

---

---

---

# SYSTEM BOARD

---

# INSTALLATION AND OPERATION

---

---

---

---

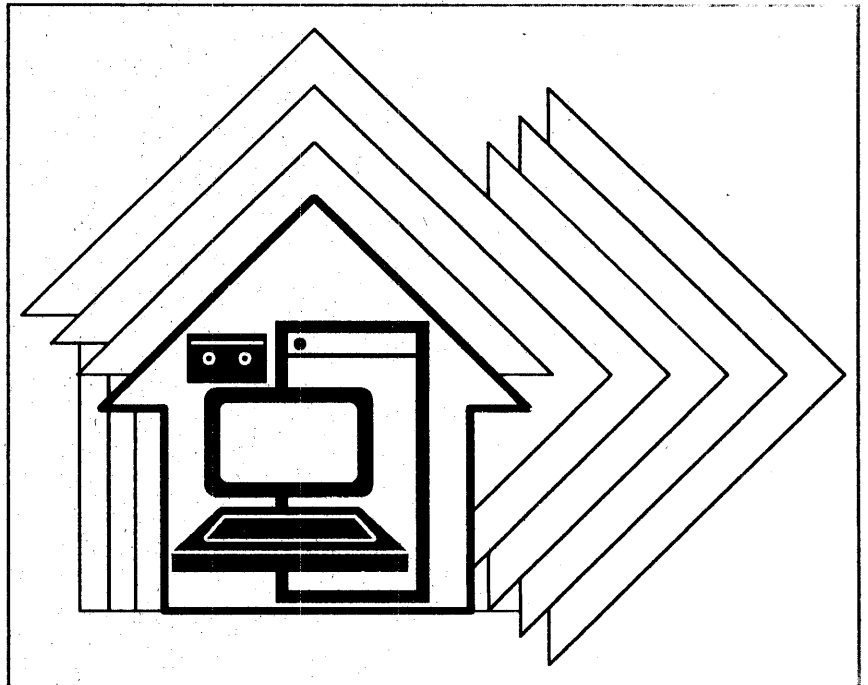

# SYSTEM BOARD INSTALLATION AND OPERATION

---

---

**NOTICE TO U.S.A. USERS:** This equipment generates, uses, and can radiate radio frequency energy and if not installed and used in accordance with the instructions manual, may cause interference to radio communications. It has been tested and found to comply with the limits for a Class A computing device pursuant to Subpart J of Part 15 of FCC Rules, which are designed to provide reasonable protection against such interference when operated in a commercial environment. Operation of this equipment in a residential area is likely to cause interference in which case the user at his own expense will be required to take whatever measures may be required to correct the interference.

---

---

**NOTICE TO CANADIAN USERS:** This digital apparatus does not exceed the Class A limits for radio noise emissions from digital apparatus set out in the Radio Interference Regulations of the Canadian Department of Communications.

Le présent appareil numérique n'émet pas de bruits radioélectriques dépassant les limites applicables aux appareils numériques de la classe A prescrites dans le Règlement sur le brouillage radioélectrique édicté par le ministère des Communications du Canada.

---

# MANUAL REVISION HISTORY

---

System Board Installation and Operation (2557941-0001)

Original Issue ..... November 1988  
Revision A ..... March 1989  
Revision B ..... October 1989  
Revision C ..... February 1990  
Revision D ..... December 1990  
Revision E ..... October 1991  
Revision F ..... March 1992

Copyright © 1988, 1989, 1990, 1991, 1992 Texas Instruments Incorporated. All Rights Reserved.

No part of this publication may be reproduced, stored in a retrieval system, or transmitted, in any form or by any means, electronic, mechanical, photocopying, recording, or otherwise, without the prior written permission of Texas Instruments Incorporated.

The system-defined windows shown in this manual are examples of the software as this manual goes into production. Later changes in the software may cause the windows on your system to be different from those in the manual.

## RESTRICTED RIGHTS LEGEND

Use, duplication, or disclosure by the Government is subject to restrictions as set forth in subdivision (c)(1)(ii) of the Rights in Technical Data and Computer Software clause at DFAR 252.227-7013.

Texas Instruments Incorporated  
ATTN: Information Technology Group, M/S 2151  
P.O. Box 149149  
Austin, Texas 78714-9149

Produced by the Publishing Center  
Texas Instruments Incorporated  
Information Technology Group  
Austin, Texas

---

## ABOUT THIS MANUAL

---

### **Purpose**

This manual provides installation and operation information for the Texas Instruments NuBus™ system boards. The information in this document is intended to be used primarily by system designers, value-added-resellers, maintenance personnel, and system users.

---

### **Contents of This Manual**

This manual is organized into four major parts, each identified by a title page. Each part contains a detailed table of contents, one or more sections, and an individual index. A general outline of the manual is as follows:

<b>Title</b>	<b>Contents</b>
68020 Processor	Section 1, Processor and Memory Section 2, 68020 Processor Unpacking Section 3, 68020 Processor Installation and Operation
68030 Symmetric Processor	Section 1, 68030 Processor Introduction Section 2, 68030 Processor Unpacking Section 3, 68030 Processor Installation and Operation
68040MP Processor	Section 1, 68040MP Processor Introduction Section 2, 68040MP Processor Unpacking Section 3, 68040MP Processor Installation and Operation
16/32-Megabyte Data Buffer Board	Section 1, 16/32-Megabyte Data Buffer Board Section 2, Data Buffer Board Unpacking Section 3, Data Buffer Board Installation and Operation
NUPI-2 Board (Also known as the File Processor (SCSI))	Section 1, NUPI-2 Overview Section 2, NUPI-2 Unpacking Section 3, NUPI-2 Installation and Operation
Mass Storage Controller	Section 1, Mass Storage Controller Section 2, MSC Unpacking Section 3, MSC Installation and Operation
Communications Processor Boards	Section 1, General Description Section 2, Unpacking the Board Section 3, Communication Processor Installation

NuBus is a trademark of Texas Instruments Incorporated.

---

---

**References**

The following documents are listed for reference information:

<b>Title</b>	<b>TI Part Number</b>
<i>Introduction</i>	2555463-0001
<i>System Operation</i>	2557949-0001
<i>Computer System Site Preparation</i>	2558023-0001
<i>System Maintenance Terminal Operating Parameters</i>	2558022-0001
<i>Computer Enclosure Installation and Operation</i>	2557942-0001
<i>Peripheral Enclosure Installation and Operation</i>	2557943-0001
<i>System Board Installation and Operation</i>	2557941-0001
<i>Mass Storage Unit (MSU IIA) Installation and Operation</i>	2557935-0001
<i>WD1200 Disk Drive Installation and Operation</i>	2557944-0001
<i>Terminal Concentrator Installation and Operation</i>	2557938-0001
<i>Terminal/Printer Information</i>	2557939-0001
<i>Installation and Operation Appendixes</i>	2557946-0001
<i>DB380 Disk Drive Field Maintenance Supplement</i>	2557953-0001
<i>DB760 Disk Drive Field Maintenance Supplement</i>	2555402-0001
<i>CT150 Tape Drive Field Maintenance Supplement</i>	2558007-0001
<i>CT2000 Tape Drive Field Maintenance Supplement</i>	2557951-0001
<i>WD1200 Disk Drive Field Maintenance Supplement</i>	2557952-0001
<i>Computer Enclosure/Peripheral Enclosure Field Maintenance Supplement</i>	2557961-0001
<i>68030 Symmetric Processor Field Maintenance Supplement</i>	2558002-0001
<i>16/32-Megabyte Data Buffer Board Field Maintenance Supplement</i>	2558003-0001
<i>NUPI-2 Board Field Maintenance Supplement</i>	2564103-0001
<i>NuBus Systems System 1500 Field Maintenance Handbook</i>	2549258-0001

**68020  
PROCESSOR**

---

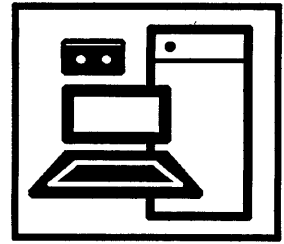



# CONTENTS

---

Paragraph	Title	Page
<b>1</b>	<b>Processor and Memory</b>	
1.1	Introduction .....	1-1
1.2	Processor Board .....	1-1
1.3	Board Address Assignment .....	1-3
1.4	Memory Expansion .....	1-3
1.5	Software Protection Adapter .....	1-3

---

<b>2</b>	<b>68020 Processor Unpacking</b>	
2.1	Unpacking the System Board and Associated Cable Adapters .....	2-1

---

<b>3</b>	<b>68020 Processor Installation and Operation</b>	
3.1	System Board Installation .....	3-1
3.2	TI-Installed System Board and Associated Cable Adapters .....	3-1
3.3	Processor Board Installation .....	3-2
3.3.1	Installing the Memory Expansion .....	3-3
3.3.2	Installing the Processor Board .....	3-4
3.3.3	Installing the Software Protection Adapter .....	3-4
3.3.4	Installing the SMT Cable .....	3-5
3.3.5	Installing the SMT .....	3-6
3.3.6	SMT Parameters .....	3-6
3.4	Operation of the Processor Board LED Indicators .....	3-7

---

## Index

---

Figure	Title	Page
<b>Figures</b>		
1-1	Processor Board .....	1-2
1-2	System 1500 Expansion Memory Board .....	1-3
1-3	Software Protection Adapter .....	1-4
2-1	System Board Shipping Container .....	2-2
2-2	Typical Cable Adapter Shipping Container .....	2-3
3-1	Processor Board, Memory Option, and Cabling .....	3-3
3-2	Software Protection Adapter .....	3-6

---





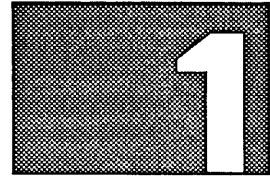

## PROCESSOR AND MEMORY

---

### Introduction

1.1 The System 1500 can have one or multiple processors in its system enclosure. The processor in the lowest numbered slot is selected by software to be the system-test-boot-master (STBM) processor. The software protection adapter (SPA) must be installed on P2 of the slot containing the STBM processor, and the system maintenance terminal (SMT) must be attached to one of the two ports on the SPA. If the SMT is local to the system enclosure, it should be connected to the 9600-baud port. If the SMT is not local to the system enclosure, a modem can be attached to the 1200-baud port of the SPA for communications to a remote system maintenance terminal.

---

### Processor Board

1.2 The System 1500 processor in Figure 1-1, a single board, uses the 68020 32-bit microprocessor. The processor operates on the NuBus™ and supports limited input/output through the SMT port. Key features of the processor are:

- Virtual memory — For sharing system operations, addressable to 4 gigabytes
- Three main buses — For addresses and data
- 68020 microprocessor — For system operation and control, operating at 16.7 MHz
- 68881 floating-point coprocessor — For floating point calculations
- 68851 paged-memory management unit (PMMU) — For memory control
- Cache memory — For logical address, data, and instructions, 16 kilobytes
- Main memory — For software operations, 2 megabytes of error-correcting onboard memory with an optional 2 or 8 megabytes of memory on a piggyback board
- Interrupt control chip (ICC) — For handling board and bus interrupts
- Three timers — For real-time clock, interval timing, and time accounting
- Nonvolatile random-access memory (NVRAM) — For system configuration support
- Read-only memory (ROM) — For board information and self-test

The following figure shows a block diagram of the System 1500 processor board.

NuBus is a trademark of Texas Instruments Incorporated.

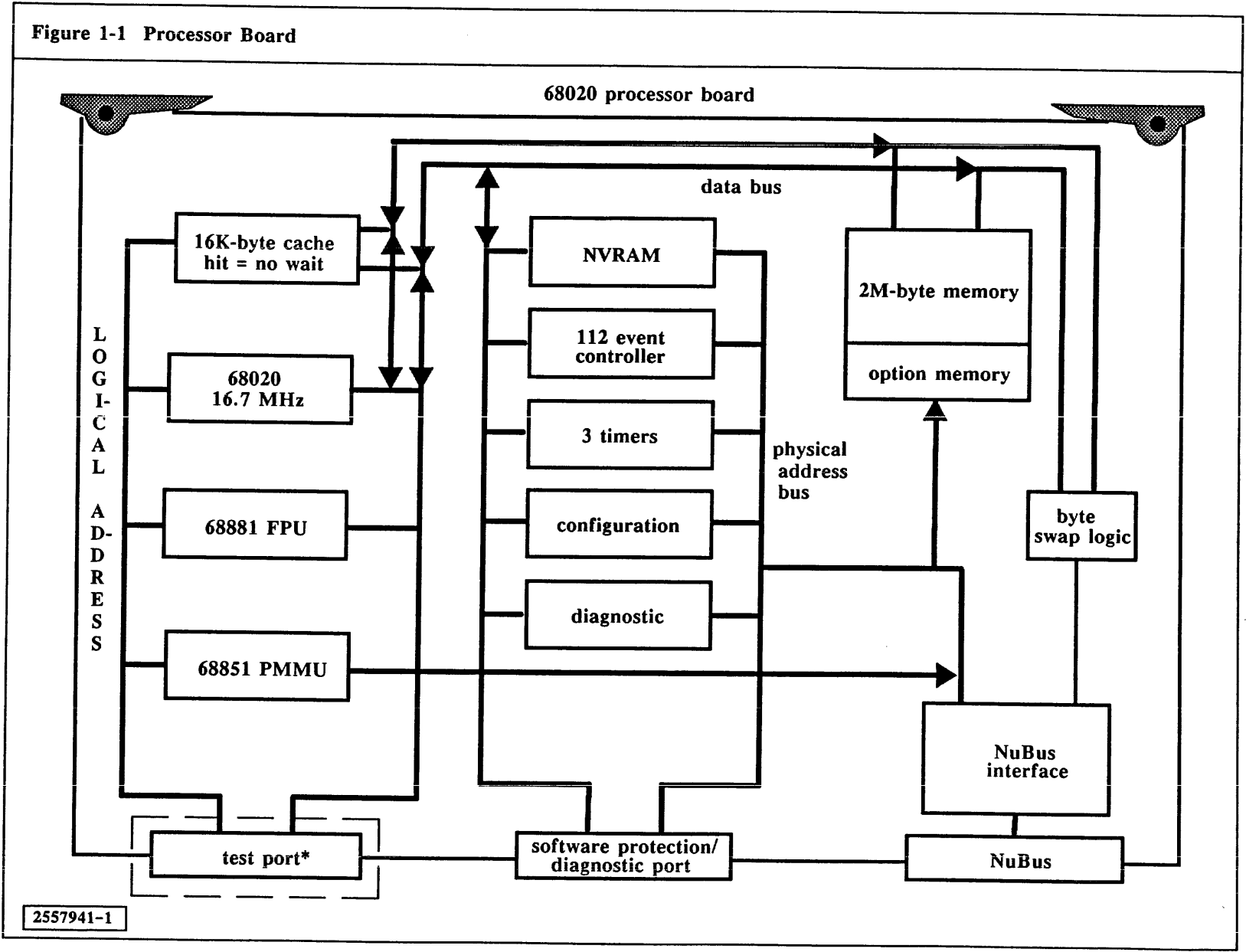

**Board Address Assignment**

1.3 The address of the processor is determined by the slot ID of the slot the processor occupies. No address switches or jumpers are needed on the processor board. The slot IDs are hardwired. A processor board has an address range of  $F(S)000000$  through  $F(S)FFFFFF$ , where ( $S$ ) is the slot address in the range of 0 through F. The 7-slot enclosure uses only the slot addresses of 0 through 6.

**Memory Expansion**

1.4 Memory expansion is possible by keeping the same control logic and expanding the even and odd storage arrays. The piggyback expansion memory board (Figure 1-2) provides an additional 2 or 8 megabytes of memory.

Figure 1-2 System 1500 Expansion Memory Board

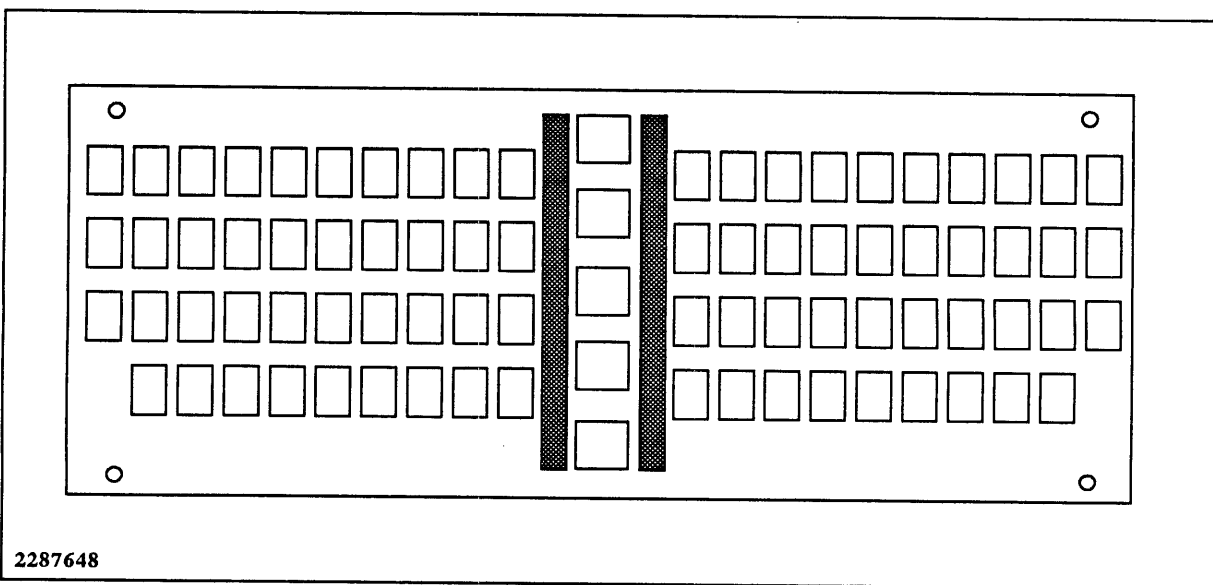
**Software Protection Adapter**

1.5 The SPA (Figure 1-3) protects the operating system software. Only one SPA is used per system. The SPA mounts on the P2 connector of the backplane slot containing the processor board. For systems with multiple processors, the SPA should be installed on the P2 connector of the lowest-numbered slot that contains a processor board; however, any slot that contains a processor board is sufficient. Affixed to the metal cover of the SPA is a label. The label contains the identification number of the SPA, and each SPA has a unique ID. The ID code of the SPA must match the password that is in the boot software.

Figure 1-3

Software Protection Adapter

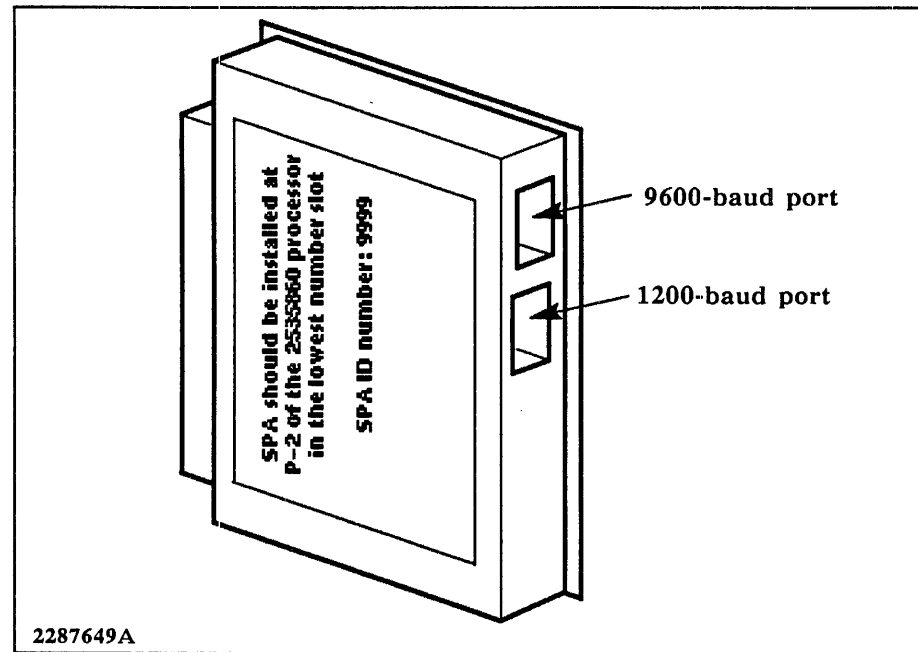

## 68020 PROCESSOR UNPACKING

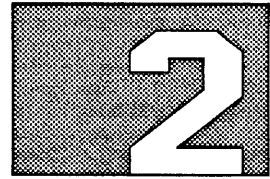

### Unpacking the System Board and Associated Cable Adapters

2.1 System owners who install their own system boards and associated cable adapters should perform the following steps to unpack the equipment:

1. Visually inspect the shipping container for damage. If the inspection reveals damage to the shipping container, contact the carrier agent for instructions on filing a claim. The carrier, not Texas Instruments, is responsible for damage during shipment. Resolve all problems relating to shipping damage before proceeding with the installation.
2. Note on the delivery receipt any problems that you discover.
3. Be sure that the driver has signed the delivery receipt.
4. Obtain a knife for cutting the sealing tape that secures the system board and the cable adapter packing containers.

---

**CAUTION:** The system board contains static-sensitive electronic components. To avoid damage to these components, ensure that you are well grounded before handling the system board.

The recommended method is to use a static-control system consisting of a static-control floor or table mat and a static-control wrist strap. These are commercially available. If you do not have a static-control system, you can discharge any accumulated static charge by touching a grounded object prior to handling the system board.

Before storing or transporting the system board, return it to its protective package.

---

---

**WARNING:** Some of the system boards have a lithium battery that will discharge and possibly explode if the positive and negative terminals of the battery are shorted together. DO NOT place the system board on a conductive surface, such as the outside surfaces of the static-protective shipping bag, as this can discharge the battery. The outside surface of all static-protective shipping bags are conductive.

---

5. As you unpack the system board (Figure 2-1) and the associated cable adapters (Figure 2-2), inspect the equipment for shipping damage. If the inspection reveals damage that you feel is significant, stop the unpacking procedure and contact the carrier agent. After the carrier agent inspects the damage, contact a Texas Instruments Field Service office. Save all the packing material for future use whenever possible.

Figure 2-1

System Board Shipping Container

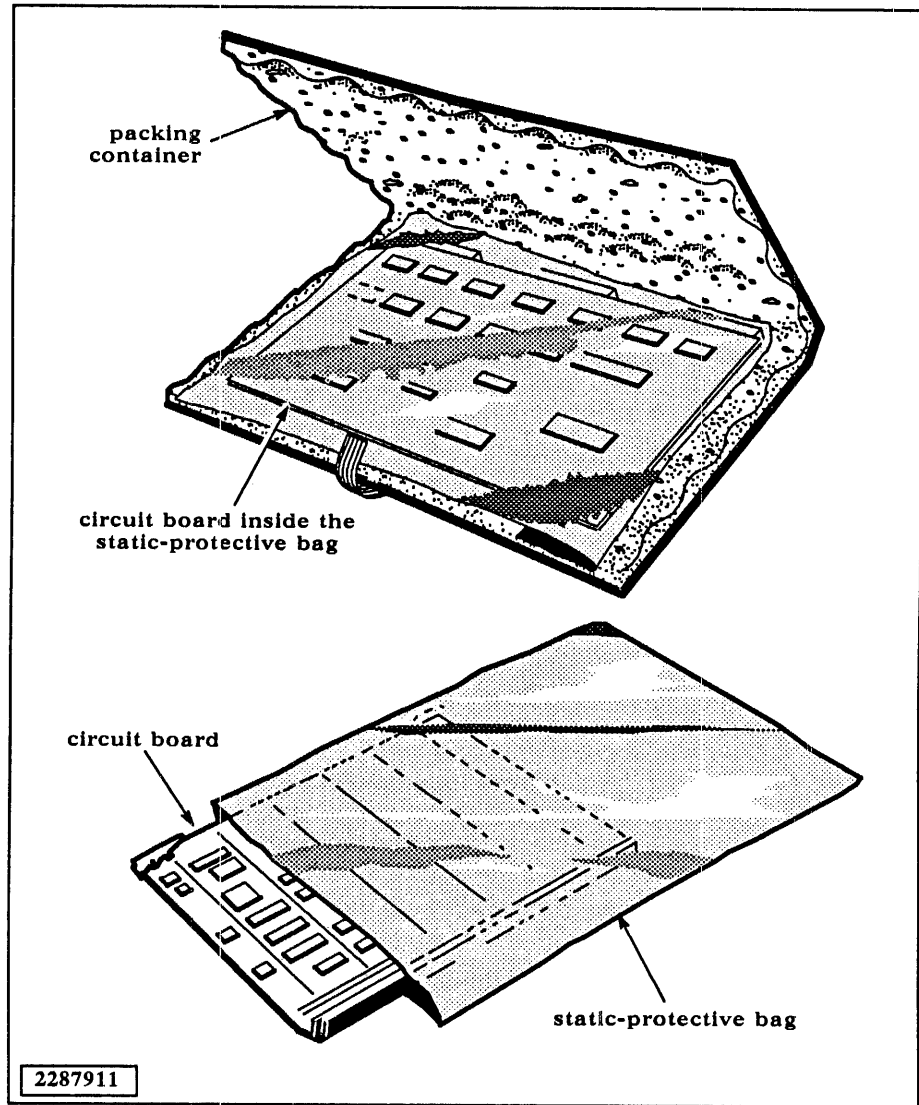
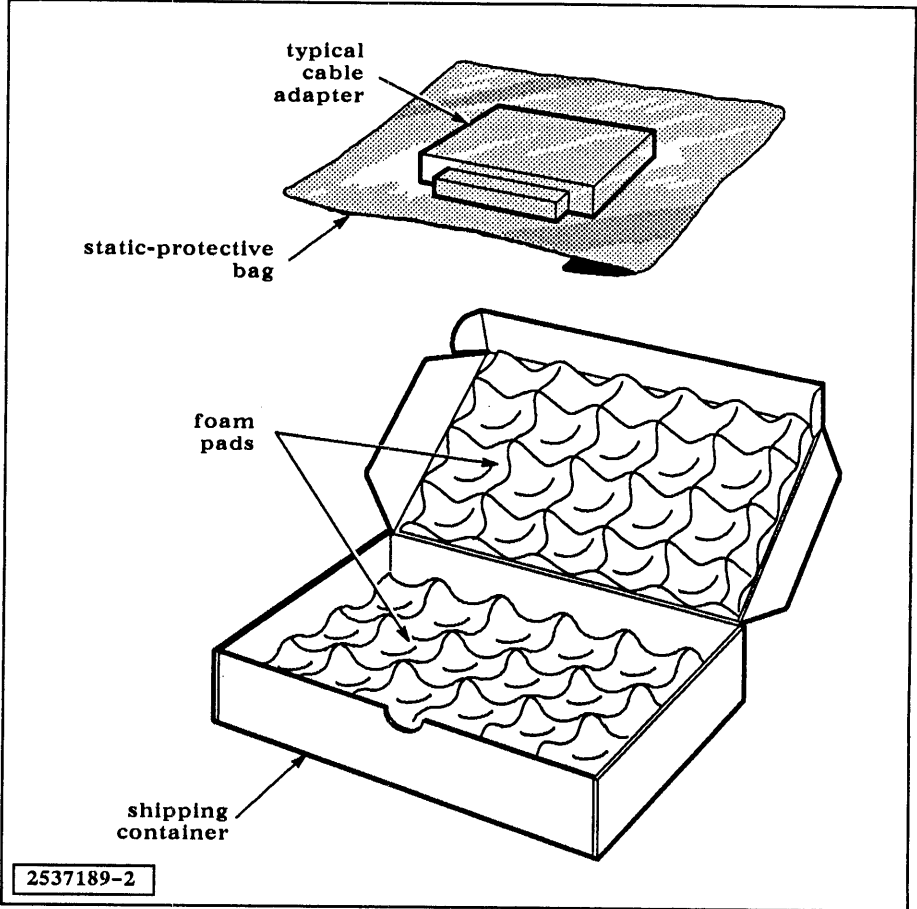

Figure 2-2

Typical Cable Adapter Shipping Container





# 68020 PROCESSOR INSTALLATION AND OPERATION

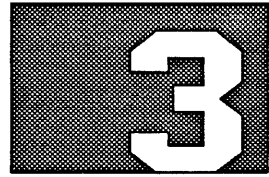

---

## System Board Installation

3.1 The system board may be shipped installed in the enclosure, or depending on your system configuration and options, you may have to install the boards. You also may have to install the system board when upgrading your system.

---

## TI-Installed System Board and Associated Cable Adapters

3.2 The following procedure outlines the tasks you must perform before TI installs your system board and associated cable adapters:

1. Note the serial number on the box that contained this manual.
2. Call the Field Service Communications Center (FSCC) at telephone number 1-800-572-3300 to schedule a site inspection (if required) and the equipment installation. Refer to your system installation manual for site requirements. The following information is required to schedule a TI installation:
  - System serial number
  - Customer name
  - Customer street address, city, state, and zip code
  - Name and telephone number of customer personnel to contact
  - Purchase order number if the installation was not ordered with the equipment

---

**WARNING:** To eliminate the possibility of electrical shock during option or upgrade installation, you must isolate the system enclosure from all potential energy sources. To isolate the system enclosure:

1. Power off the system enclosure and all peripherals.
  2. Disconnect the power cable from the wall outlet of all local peripherals connected to the system enclosure.
  3. Disconnect all interface cables between the system enclosure and all remote peripherals.
  4. Unplug the system enclosure power cable from the wall outlet.
-

---

**CAUTION:** All boards, options, adapters, and peripherals contain components that are sensitive to static electricity. When handling any of these items, protect against static electricity by using wrist grounding straps, grounded working mats, and antistatic bags for moving or storing the items.

---

---

## **Processor Board Installation**

3.3 Each processor board contains 2 megabytes of on-board memory and can support an additional 2 or 8 megabytes of piggyback expansion memory. Each System 1500 system enclosure must have one software protection adapter (SPA). Only persons knowing the correct login codes can gain access to the system. Each system enclosure must have one system maintenance terminal (SMT). The SMT is used in the initial boot of the system software and for running the disk-resident diagnostics. The following figure shows the processor board, the SPA, the SMT cable, the SMT, and the memory expansion board.

---

**WARNING:** Each processor board contains a lithium battery. Lithium batteries can explode if the positive and negative terminals are shorted together. **DO NOT** place the processor board on a conductive surface. The outside surfaces of all antistatic shipping bags are conductive; do not place the processor on an antistatic shipping bag.

---

When working with the processor board, you must be careful not to short circuit the real-time clock battery. The battery is located at the upper front corner, behind the stiffener, of the processor board. Do not place the processor on top of the antistatic shipping bag; the outer surface of the shipping bag is conductive.

Figure 3-1 Processor Board, Memory Option, and Cabling

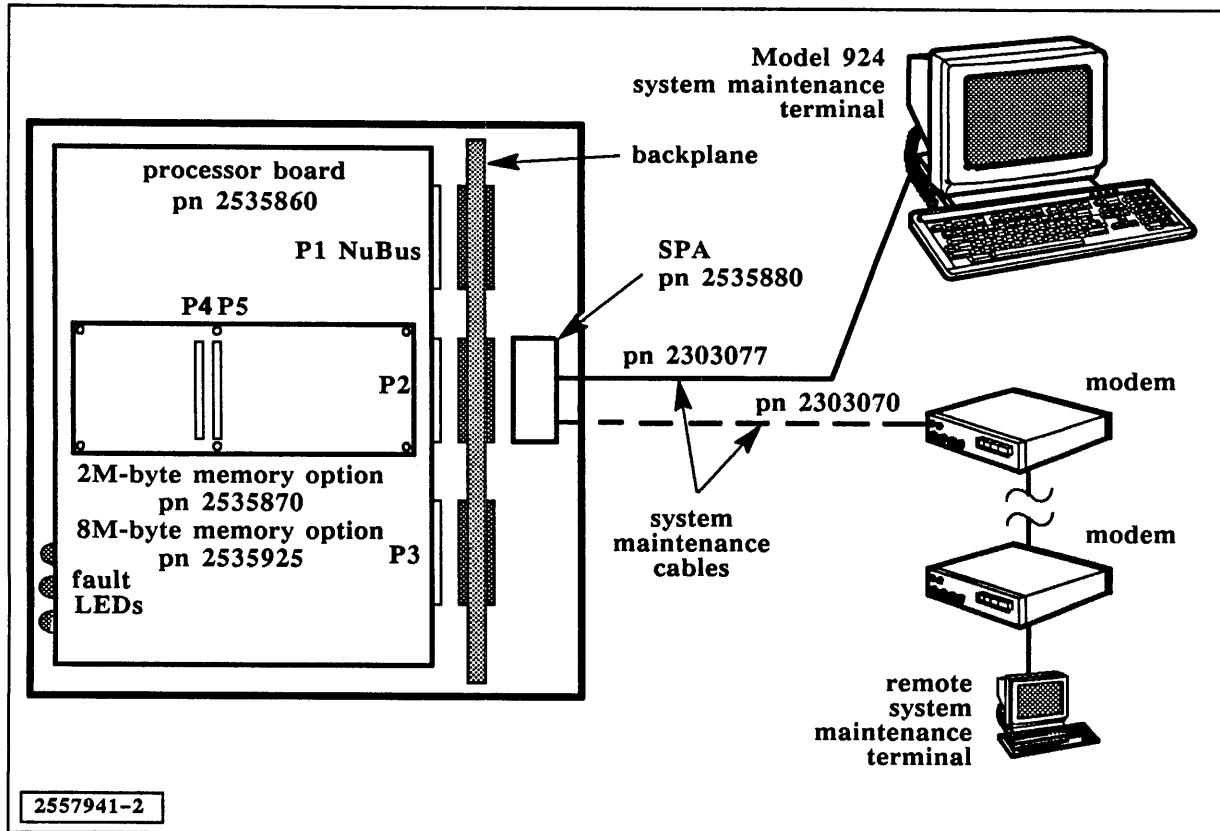

### Installing the Memory Expansion

3.3.1 The memory expansion board contains 2 or 8 megabytes of add-on memory for the processor board. The connectors located at the center of the expansion board mate with the two sets of pins located near the center of the processor board. There are six mounting holes on the processor and six mounting standoffs on the expansion board. The center set of holes and standoffs are offset to ensure that the expansion board can be mounted in only one orientation. To mount the expansion board:

1. Remove the processor board from the system enclosure or its antistatic shipping bag, and place it on a nonconductive antistatic surface.

**WARNING:** Each processor board contains a lithium battery. Lithium batteries can explode if the positive and negative terminals are shorted together. **DO NOT** place the processor board on a conductive surface. The outside surfaces of all antistatic shipping bags are conductive; do not place the processor on an antistatic shipping bag.

2. Position the expansion board over the processor board so that all six of the mounting holes and mounting studs are aligned.

3. Press the expansion board connectors onto the processor board mounting pins. Check to make sure that no pins were bent during the mounting of the expansion board. If a pin is bent, proceed as follows:
  - a. Carefully lift the memory expansion board from the processor board.
  - b. With a pair of longnose pliers, carefully straighten the bent pin.
  - c. Try again to install the memory expansion board.
4. Install the six screws and washers that hold the expansion board to the processor board. With a  $\frac{3}{16}$  inch nut driver, tighten the screws firmly; do not over-tighten.
5. Install the upgraded processor board in the enclosure card cage.

---

**Installing the  
Processor Board**

**3.3.2** Access to the system backplane varies with the particular enclosure. Refer to the *Computer Enclosure Installation and Operation* manual for instructions on gaining access to the backplane and the actual insertion of the 68020 board.

---

**Installing the  
Software Protection  
Adapter**

**3.3.3** The SPA protects your software from unauthorized use; system users must know the correct password to access system software. Each system enclosure has only one SPA.

For a system with one processor board, the SPA attaches on the backplane at P2 of the slot containing the processor board. The processor can go in any slot. The system boots from the processor board in the lowest numbered slot. The slots are numbered from right to left as you face the rear of the system enclosure. The SPA must go on P2 of the processor that boots the system.

Each SPA has an ID number located on the SPA board protective cover. Record the SPA ID number and the sales order number from the SPA label. You will need these numbers along with your customer number when obtaining your system login code from Texas Instruments Incorporated. Information on obtaining the login code can be found in the *System Operation* manual.

To install the SPA in a system with one processor board, perform the following steps:

1. Power off the computer enclosure and peripheral enclosure. Remove the ac power cord from the wall outlet.
2. Refer to the *Computer Enclosure Installation and Operation* manual for instructions on gaining access to the rear of the backplane. Locate P2 of the slot containing the processor board.
3. Position the SPA so that the shield faces to the left, the 96-pin connector faces toward the backplane, and the two 18-pin cable ports are at the top of the SPA, facing out from the backplane.
4. Slide the SPA into the mounting rails until it is seated in the backplane P2 connector. Refer to paragraph 3.3.4 and connect the cable from the SMT to the SPA.

5. Restore the enclosures to the physical condition they were in prior to this procedure.
6. Reinstall the ac power cable, and power on the peripheral enclosure and the computer enclosure.

To install the SPA in a system with more than one processor board, perform the following steps:

1. Power off the computer enclosure and peripheral enclosure. Remove the ac power cord from the wall outlet.
2. Refer to the *Computer Enclosure Installation and Operation* manual for instructions on gaining access to the rear of the backplane. Locate P2 of the lowest numbered slot containing a processor board.
3. Position the SPA so that the shield faces to the left, the 96-pin connector faces toward the backplane, and the two 18-pin cable ports are at the top of the SPA facing out from the backplane.
4. Slide the SPA into the mounting rails until it is seated in the backplane P2 connector. Refer to paragraph 3.3.4 and connect the cable from the SMT to the SPA.
5. Restore the enclosures to the physical condition they were in prior to this procedure.
6. Reinstall the ac power cable, and power on the peripheral enclosure and the computer enclosure.

#### Installing the SMT Cable

---

3.3.4 The SMT cable provides an interface between the SPA and the SMT. The lower cable connector on the SPA supports a baud rate of 1200 and is used when connecting the SPA to a modem for remote location support and system boot operation. The upper cable connector on the SPA supports a baud rate of 9600 and is used to connect a video display terminal (VDT). To install the SMT cable, proceed as follows:

---

**NOTE:** The system supports only one SMT. Do not connect more than one SMT cable to the SPA at a time.

---

1. Power off the system enclosure and peripherals. Remove the ac power cord from the system enclosure.
2. Refer to the *Computer Enclosure Installation and Operation* manual for instructions on gaining access to the rear of the backplane.
3. Route the 18-pin connector of the SMT cable to the SPA.

4. Attach the 18-pin cable connector to the port corresponding to the speed of the device you are installing as follows:
  - Upper port — 9600 bits per second
  - Lower port — 1200 bits per second
5. Attach the other end of the cable to the appropriate device, a VDT, or a modem.
6. Restore the enclosures to the physical condition they were in prior to this procedure.
7. Reinstall the ac power cable, and power on the peripheral enclosure and computer enclosure.

Figure 3-2

## Software Protection Adapter

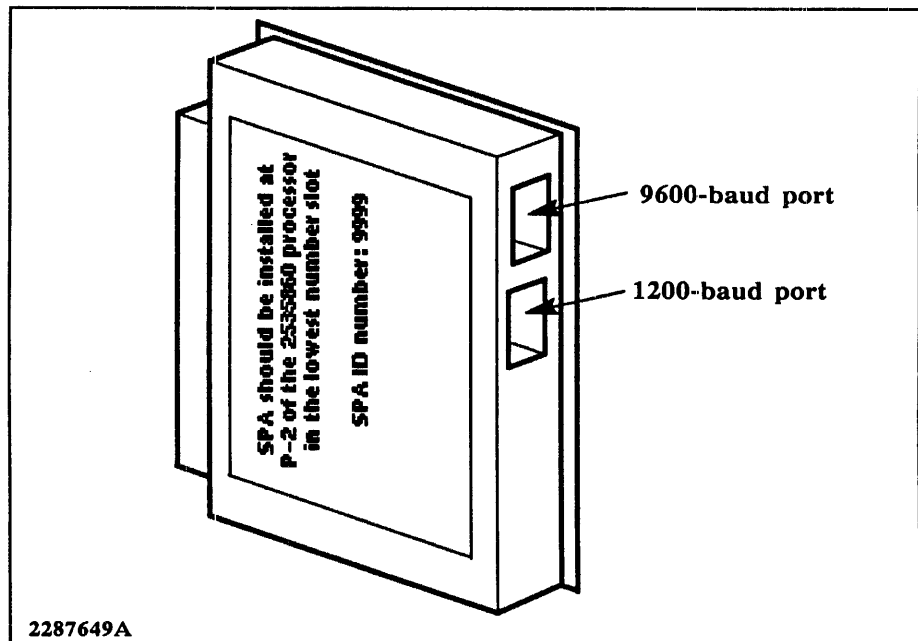

## Installing the SMT

3.3.5 The SMT is used exclusively for system booting, error reporting, extended self-tests, and diagnostics control. The standard SMT is the Model 924 VDT, but a Model 931 VDT can also be used. Refer to the *Terminal/Printer Information* manual for information on installing the VDT that your system will use as the SMT.

## SMT Parameters

3.3.6 The SMT must be set for the appropriate parameters for correct operation during the boot process. Refer to the *System Operation* manual for information on the system boot process.

---

**Operation of the  
Processor Board  
LED Indicators**

3.4 The operation of the processor board LEDs is as follows:

- Top — Correctable memory error
- Center — Uncorrectable memory error
- Bottom — Board fault

# INDEX

---

## A

address assignment: 68020 1-3

## B

boards

general description: 68020 1-1-1-2

installation: 68020 3-2-3-6

shipping container: 68020 2-2

TI installation: 68020 3-1-3-2

unpacking: 68020 2-1-2-3

## C

cable adapters

shipping container: 68020 2-3

TI installation: 68020 3-1-3-2

unpacking: 68020 2-1-2-3

cautions, static electricity: 68020 2-1, 3-2

## E

electrical shock warning: 68020 3-1

## I

indicators, LED: 68020 3-7

installation

cable adapters: 68020 3-1-3-2

cautions: 68020 3-2

memory expansion board: 68020 3-3-3-4

processor board: 68020 3-4

software protection adapter (SPA): 68020 3-4-3-5

system boards: 68020 3-1-3-7

system maintenance terminal (SMT):  
68020 3-6

system maintenance terminal cable: 68020 3-5-3-6

warnings: 68020 3-1, 3-2, 3-3

## L

LED indicators: 68020 3-7

lithium battery warning: 68020 2-1, 3-2, 3-3

## M

memory expansion board

general description: 68020 1-3

installation: 68020 3-3-3-4

## P

processor board

address assignment: 68020 1-3

figure: 68020 1-2

general description: 68020 1-1-1-2

installation: 68020 3-2-3-6

LED indicators: 68020 3-7

memory expansion board: 68020 1-3,  
3-3-3-4

software protection adapter (SPA): 68020 1-3-1-4

## S

shipping container

cable adapter: 68020 2-3

system board: 68020 2-2

software protection adapter (SPA)

general description: 68020 1-3-1-4

installation: 68020 3-4-3-5

static electricity caution: 68020 2-1, 3-2

system boards. *See* boards

system maintenance terminal (SMT)

cable installation: 68020 3-5-3-6

installation: 68020 3-6

## T

TI-installation

cable adapters: 68020 3-1-3-2

system boards: 68020 3-1-3-2

## U

unpacking

cable adapters: 68020 2-1-2-3

cautions: 68020 2-1

system boards: 68020 2-1-2-3

warnings: 68020 2-1

## W

warnings

electrical shock: 68020 3-1

lithium battery: 68020 2-1, 3-2, 3-3



**68030 SYMMETRIC  
PROCESSOR**

---

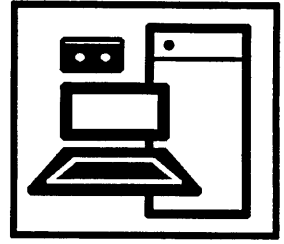



# CONTENTS

---

Paragraph	Title	Page
<b>1</b>	<b>68030 Processor Introduction</b>	
1.1	Introduction .....	1-1
1.2	Features .....	1-4
1.3	Specifications .....	1-5
1.4	Reference Documents .....	1-6
<b>2</b>	<b>68030 Processor Unpacking</b>	
2.1	Introduction .....	2-1
2.2	Unpacking .....	2-1
<b>3</b>	<b>68030 Processor Installation and Operation</b>	
3.1	Introduction .....	3-1
3.2	Configuration Restrictions .....	3-1
3.3	Arranging for TI Installation .....	3-2
3.4	Installation Procedures .....	3-2
3.4.1	Installing the Memory Expansion .....	3-3
3.4.2	Installing the Processor Board .....	3-6
3.4.3	Installing the SPA .....	3-7
3.4.4	Installing the SMT Cable .....	3-9
3.5	LED Indicator Operation .....	3-10

---

Index

	Figure	Title	Page
<b>Figures</b>	1-1	68030 Symmetric Processor .....	1-2
	1-2	68030 Memory Expansion Board .....	1-3
	1-3	Software Protection Adapter .....	1-4
	2-1	System Board Shipping Container .....	2-2
	2-2	Typical Cable Adapter Shipping Container .....	2-3
	3-1	68030 Processor, Memory Expansion, SPA, and Cabling .....	3-3
	3-2	Memory Expansion Mounting Provisions on the Processor Board .....	3-5
	3-3	Memory Expansion Mounted on the Processor Board .....	3-6
	3-4	Software Protection Adapter .....	3-10
	3-5	Processor Board LED Indicators .....	3-11

	Table	Title	Page
<b>Table</b>	1-1	68030 Symmetric Processor Specifications .....	1-5

# 68030 PROCESSOR INTRODUCTION

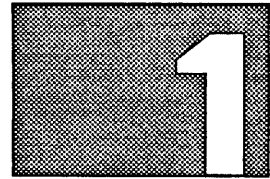

---

## Introduction

1.1 This section provides an introduction to the 68030 symmetric processor board, the optional 68030 memory expansion, and the software protection adapter (SPA). This information is organized into three major topics:

- Features
- Specifications
- Reference documents

The 68030 symmetric processor (Figure 1-1) is an advanced general-purpose processor for use in single processor and multiprocessor computing systems based on the NuBus™ high-speed data bus. The 68030 symmetric processor provides significant performance improvements over the original 68020-based System 1500 processor, and serves as the basis for high-performance models of the System 1000 Series, System 1500 numeric/business systems.

Dynamic random-access memory (DRAM) chips on the processor board and on the piggyback memory expansion (Figure 1-2) provide local storage for processor data and instructions. Error-checking and correcting (ECC) logic protects both the on-board and expansion memories. User and supervisor cache memories provide high-speed memory access for enhanced performance.

The SPA (Figure 1-3) provides a hardware identification number for correlation with a software password required by TI System V operating system software. The SPA provides terminal connections for a system maintenance terminal (SMT), and must be installed on the processor that serves as the system test boot master.

NuBus is a trademark of Texas Instruments Incorporated.

Figure 1-1 68030 Symmetric Processor

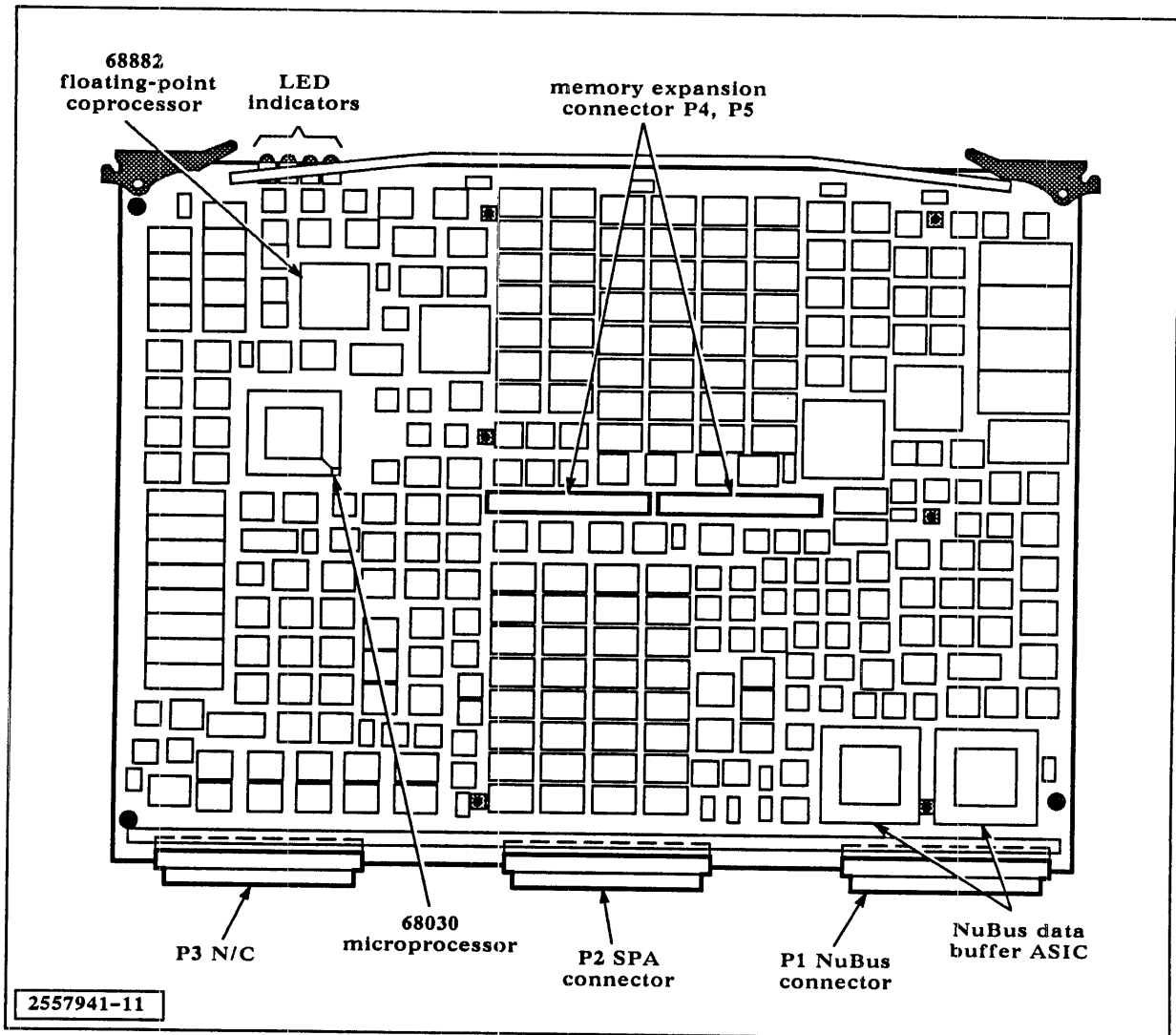

Figure 1-2 68030 Memory Expansion Board

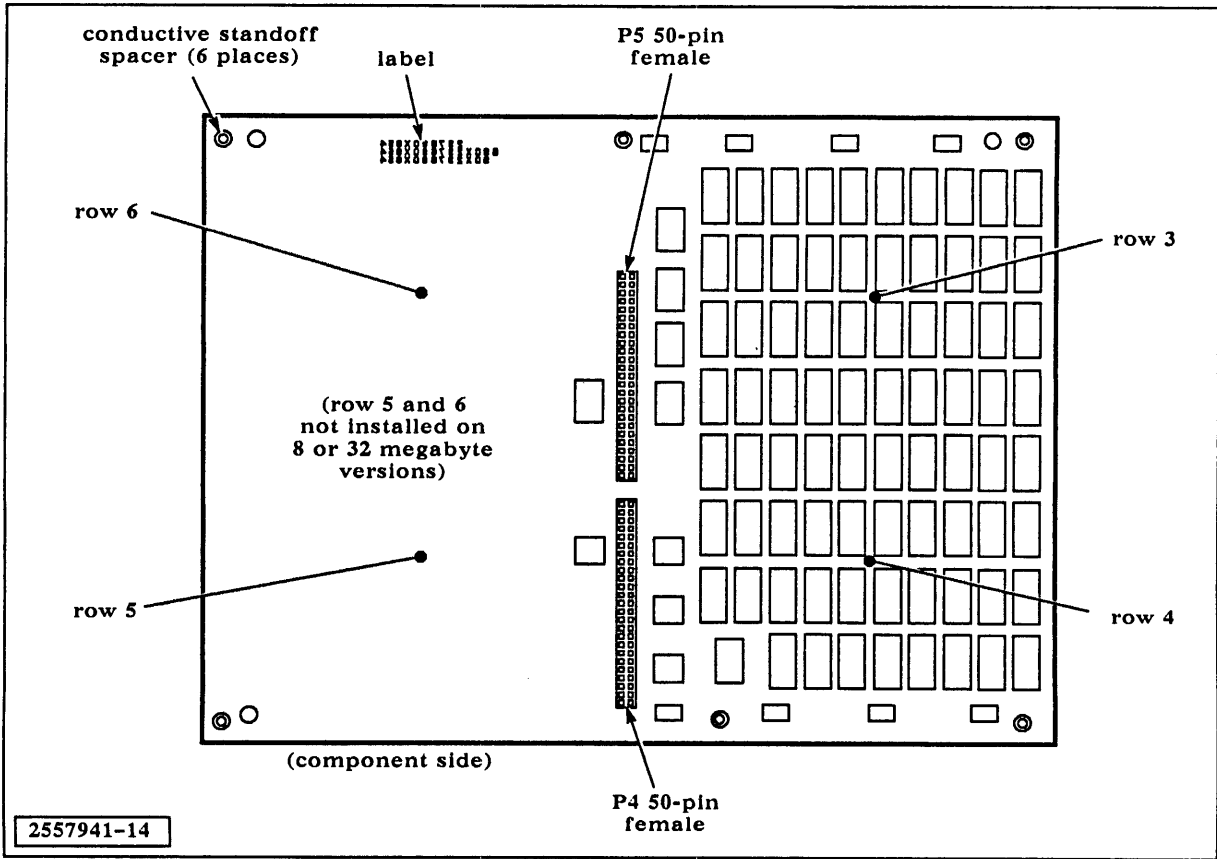
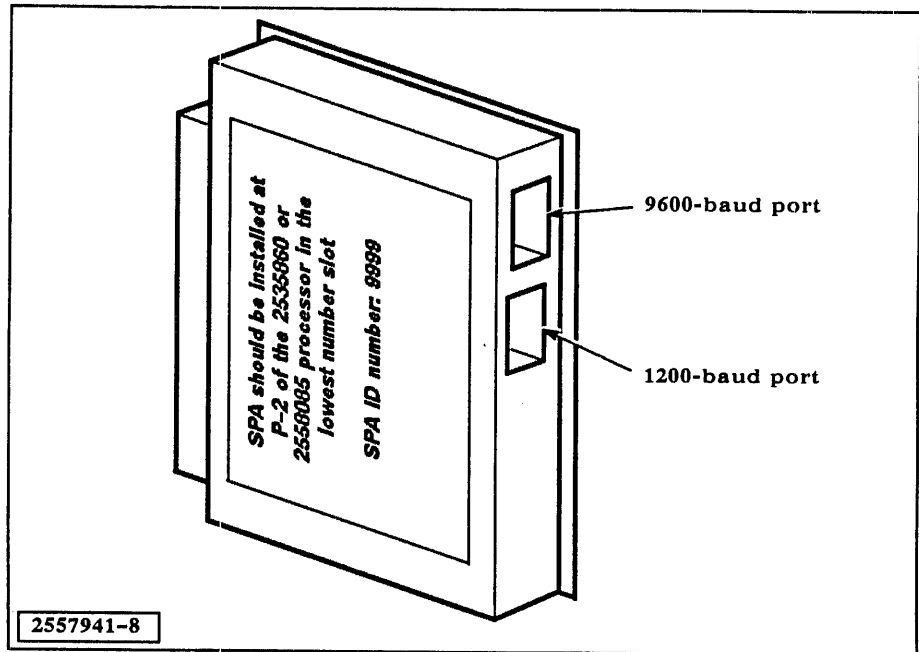

Figure 1-3

## Software Protection Adapter



## Features

1.2 The 68030 provides a number of features that enhance system performance. Key features of the processor include the following:

- The virtual memory system allows the microprocessor to access the full 4-gigabyte address space without regard to the much smaller amount of physical memory available. The demand-paged memory management scheme moves fixed-size pages of data between memory and mass storage disk drives.
- The 68030 enhanced 32-bit microprocessor, operating at 33.33 megahertz, serves as the central processor, bus controller, and memory management unit. The 68030 includes instruction pipeline logic, data and instruction cache memories, and other enhancements for high-speed operation.
- The 68882 floating-point coprocessor, operating at 33.33 megahertz, provides high-speed floating-point arithmetic operations that conform to the IEEE floating-point standard.
- Separate 32-kilobyte user and 32-kilobyte supervisor cache memories provide high-speed access to often-used data and instructions.
- Main memory provides 8 or 32 megabytes of on-board memory with optional expansion to 64 megabytes. ECC logic protects against memory errors.
- Dual-bus architecture separates shared resources from processor-only resources, allowing overlap of microprocessor local bus cycles and NuBus input/output cycles.



- Nonvolatile random-access memory (NVRAM) with an internal battery provides storage for system configuration parameters.
- Read-only memory (ROM) stores permanent board information and self-test programs.
- The interrupt control chip (ICC) handles board interrupts and NuBus events.
- Timers provide time accounting, interval measurement, and a battery-maintained real-time clock (RTC).
- The NuBus interface includes 16-word first-in, first-out (FIFO) buffers to maintain optimum data flow between the NuBus and the processor board.

---

## Specifications

1.3 Table 1-1 lists the hardware specifications of the 68030 symmetric processor board.

Table 1-1

---

**68030 Symmetric Processor Specifications**

---

Item	Specifications
Form factor	Triple-height Eurocard, with connectors and mounting provisions for piggyback 68030 memory expansion
Main memory	8 or 32 megabytes of ECC-protected DRAM on-board, with an additional 8, 16, or 32 megabytes on optional 68030 memory expansion
Error checking	Parallel ECC logic detects and corrects all single-bit errors and detects all 2-bit errors (on-board and expansion memory)
Cache memory	32-kilobyte user cache and 32-kilobyte supervisor cache memories using 20-nanosecond static RAM devices with parity protection
Addressing	8 megabytes accessible at the NuBus slot address, Fs000000. All memory accessible via a loadable base register that biases the on-board and expansion memory into NuBus global address space
NuBus slave operation	Supports NuBus slave reads or writes (8-bit bytes, 16-bit halfwords, or 32-bit words) from external master to memory or physical bus registers. Accepts NuBus slave block transfers of 32-bit words.
NuBus master operation	Reads or writes external slaves in bytes, halfwords, or words. Does not perform NuBus block transfers as a master.

Table 1-1

68030 Symmetric Processor Specifications (Continued)	
Item	Specifications
Clock rate	33.33-megahertz processor clock, divided from output of 66.67-megahertz crystal-controlled oscillator
Power	
Processor	+5 volts, 12.0 amperes +12 volts, 0.04 amperes -12 volts, 0.02 amperes
Memory Expansion	+5 volts, 1.2 amperes
Temperature	
Operating	10° to 35° C (50° to 95° F)
Nonoperating	-40° to 65° C (-40° to 149° F)
Wet bulb	27° C (80° F) maximum
Relative Humidity	
Operating	20% to 80% (noncondensing)
Nonoperating	5% to 95% (noncondensing)

## Reference Documents

1.4 For additional technical information on the 68030 symmetric processor and its application in different computing systems, refer to the following documents:

- *IEEE Standard for a Simple 32-Bit Backplane Bus: NuBus*, IEEE Standard 1196-1987, (Institute of Electrical and Electronics Engineers, Inc.)
- *NuBus System Architecture General Description*, TI part number 2537171-0001
- *IEEE Standard for Binary Floating-Point Arithmetic*, ANSI/IEEE Standard 754-1985, (Institute of Electrical and Electronics Engineers, Inc.)
- *TI System V Administrator's Guide*, TI part number 2540539-0001
- *68030 Symmetric Processor Field Maintenance Supplement*, TI part number 2558002-0001
- *NuBus Systems System 1500 Field Maintenance*, TI part number 2549258-0001

## 68030 PROCESSOR UNPACKING

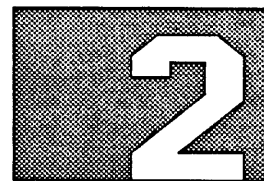

---

### Introduction

2.1 This section describes how to unpack and handle the 68030 symmetric processor, the 68030 memory expansion, and the software protection adapter (SPA).

The 68030 symmetric processor kit is packed in a system board shipping container (Figure 2-1). If you purchased a memory expansion, the board is packed in the same way as the processor, in a smaller box. The SPA is packed in a cable adapter shipping container (Figure 2-2).

---

### Unpacking

2.2 System owners who install their own system boards should perform the following steps to unpack the equipment:

1. Visually inspect the shipping container for damage. If the inspection reveals damage to the shipping container, contact the carrier agent for instructions on filing a claim. The carrier, not Texas Instruments, is responsible for damage during shipment. Resolve all problems relating to shipping damage before proceeding with the installation.
2. Note on the delivery receipt any problems that you discover.
3. Be sure that the driver has signed the delivery receipt.
4. Obtain a knife for cutting the sealing tape that secures the system board and the cable adapter packing containers.

---

**CAUTION:** The processor, memory expansion, and SPA circuit boards contain static-sensitive electronic components. To avoid damage to these components, ensure that you are well grounded before handling the circuit boards.

The recommended method is to use a static-control system consisting of a static-control floor or table mat and a static-control wrist strap. These are commercially available. If you do not have a static-control system, you can discharge any accumulated static charge by touching a grounded object prior to handling the circuit board.

Before storing or transporting any circuit board, return it to its protective antistatic package.

---

5. As you unpack the processor and expansion memory (Figure 2-1) or the SPA (Figure 2-2), inspect the equipment for shipping damage. If the inspection reveals damage that you feel is significant, stop the unpacking procedure and contact the carrier agent. After the carrier agent inspects the damage, contact a Texas Instruments Field Service office. Save all the packing material for future use whenever possible.

Figure 2-1

System Board Shipping Container

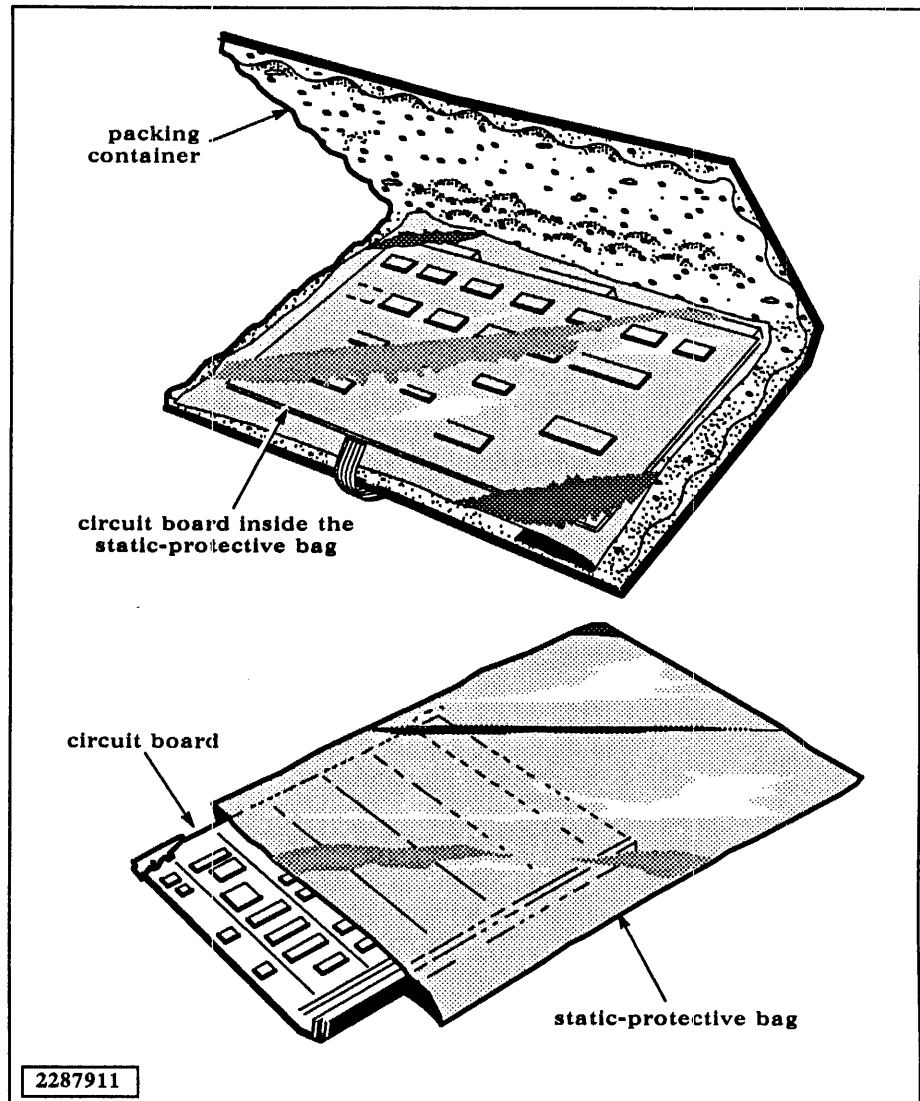
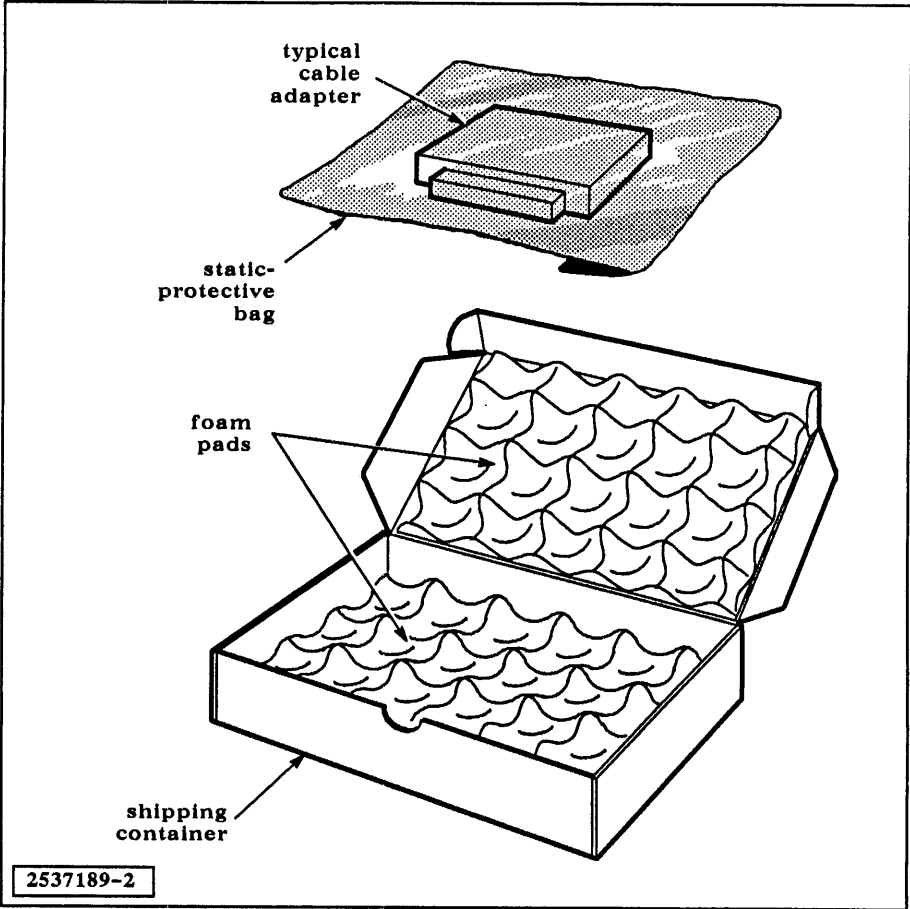
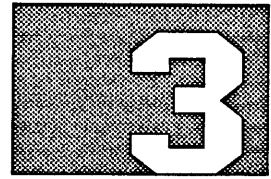

Figure 2-2

Typical Cable Adapter Shipping Container



# 68030 PROCESSOR INSTALLATION AND OPERATION



---

## Introduction

3.1 This section provides information on installation and operation of the 68030 symmetric processor, the piggyback 68030 memory expansion, and the software protection adapter (SPA). The installation instructions apply to situations where you are adding the processor and/or memory expansion to an existing computer system. If you purchase a new computer system that includes these components, Texas Instruments installs them at the factory.

If you purchase the processor and/or memory expansion to upgrade an existing system, you have the option of installing the boards yourself or having Texas Instruments perform the installation for you.

---

## Configuration Restrictions

3.2 There are hardware and software restrictions that apply to the installation and operation of the 68030 symmetric processor. These restrictions may change with hardware changes and software releases. Unless you are replacing an existing 68030 processor, you should know about these restrictions. Present restrictions include:

- TI System V, release 3.2.2 (or a later release) is required to support the 68030 symmetric processor. Systems with multiple processors require the extended symmetric processing (ESP) license for the TI System V operating system software.
- The 68030 processor is not compatible with the original 7-slot chassis with local bus backplane shipped with early Explorer™ or Explorer LX™ systems. It is compatible with the NuBus-only backplanes shipped in production models of the System 1000 Series, System 1500 computing systems.
- Multiprocessor systems may include a mix of 68030 processors and 68020 processors. However, some early-production 68020 processors are incompatible with 68030 processors and with later-production 68020 processors. Part numbers of the fully-compatible 68020 processors are:
  - 2535860-0001 (rev. AN or any later revision level)
  - 2535860-0002 (all revision levels)
- The processor board in the lowest-numbered NuBus slot serves as the system test boot master. If your system includes both 68020 processors and 68030 processors, install a 68030 processor (and SPA) in slot 0 for fastest system boot time.

Explorer and Explorer LX are trademarks of Texas Instruments Incorporated.

---

## Arranging for TI Installation

3.3 The following procedure outlines the tasks you must perform before TI installs your processor board, memory expansion, and SPA:

1. Note the serial number from the original system documents or from the box that contained this manual.
2. Call the Field Service Communications Center (FSCC) at telephone number 1-800-572-3300 to schedule a site inspection (if required) and the equipment installation. Refer to your system installation manual for site requirements. The following information is required to schedule a TI installation:
  - System serial number
  - Customer name
  - Customer street address, city, state, and zip code
  - Name and telephone number of customer personnel to contact
  - Purchase order number if the installation was not ordered with the equipment

---

## Installation Procedures

3.4 Processor installation is divided into three parts: mounting the memory expansion on the processor, installing the processor in the system enclosure, and installing the SPA. Figure 3-1 shows the relationship between the processor, the memory expansion, the backplane, and the SPA.

---

**CAUTION:** All boards, options, adapters, and peripherals contain components that are sensitive to static electricity. When handling any of these items, protect against static electricity by using wrist grounding straps, grounded working mats, and antistatic bags for moving or storing the items.

---

Figure 3-1 68030 Processor, Memory Expansion, SPA, and Cabling

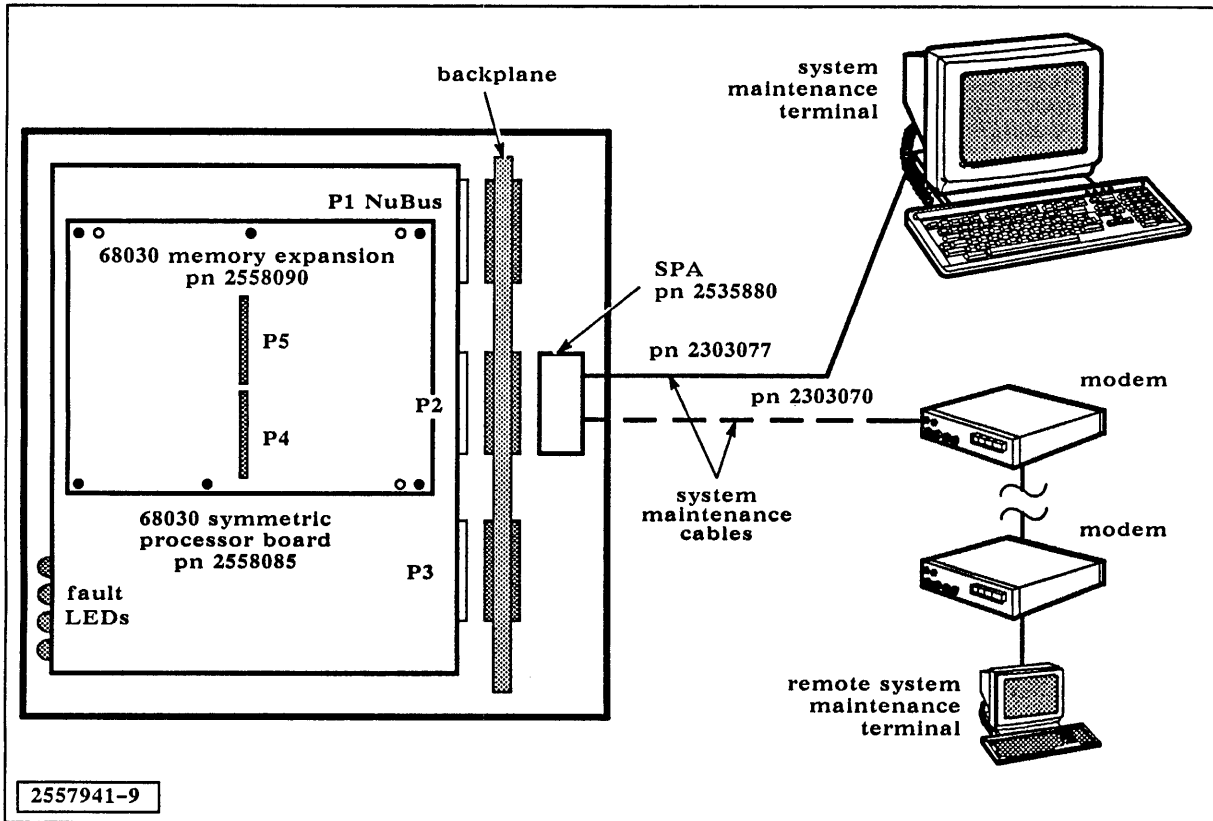

### Installing the Memory Expansion

3.4.1 The 68030 memory expansion board mounts piggyback on the 68030 processor board and does not occupy an additional NuBus slot. This board is not compatible with the 68020 processor, and the connector scheme is different to prevent confusion. An insulating shield prevents electrical contact between the memory expansion board and an adjacent NuBus circuit board.

A memory size code hardwired on the memory expansion notifies the processor of the presence and amount of additional memory. Part numbers for the different capacity boards are:

Part Number	Memory Capacity
2558090-0001	16 megabytes
2558090-0002	8 megabytes
2558090-0003	32 megabytes

The 68030 memory expansion board has two female connectors in a row at the center of the board. These female connectors mate with the two male connectors located near the center of the processor board. Six metal stand-offs on the expansion board mount on conductive pads on the processor board. The center set of standoffs and pads are offset to ensure that the expansion board can be mounted in only one orientation.



To install the expansion board on the 68030 processor board, refer to Figure 3-2 and Figure 3-3 for reference, and perform the following procedure:

1. Observe all antistatic and board-handling precautions.
2. Remove the processor board from the system enclosure or its antistatic shipping bag, and place it on an antistatic surface. Remove the memory expansion board from its antistatic shipping bag.
3. Position the expansion board over the processor board with the component side facing the processor board. Orient the expansion board over the processor board connectors so that all six of the metal standoffs and mounting pads are aligned.
4. Gently press the expansion board connectors onto the processor board connectors. Do not force the connectors. If the connectors bind, carefully lift the expansion board and check the processor board connectors for bent pins. If a pin is bent, proceed as follows:
  - a. With a pair of long-nose pliers, carefully straighten the bent pin.
  - b. Try again to install the memory expansion board.
5. Carefully thread a 2-56 machine screw and washer from the back side of the processor through the mounting pad and into the base of each metal standoff. Use care not to cross-thread the machine screws.
6. With a  $\frac{3}{16}$  inch nut driver, secure all six mounting screws firmly without over-tightening them.

---

**NOTE:** The metal standoffs carry operating voltages for the memory expansion; all six mounting screws must be present and firmly secured to insure proper operation.

---

7. Verify that the insulating shield is securely attached to the exposed wiring side of the memory expansion board. Two integral clips and two nylon push-on fasteners secure the shield in place.
8. Install the upgraded processor board in the enclosure card cage as described in the next paragraph.

Figure 3-2 Memory Expansion Mounting Provisions on the Processor Board

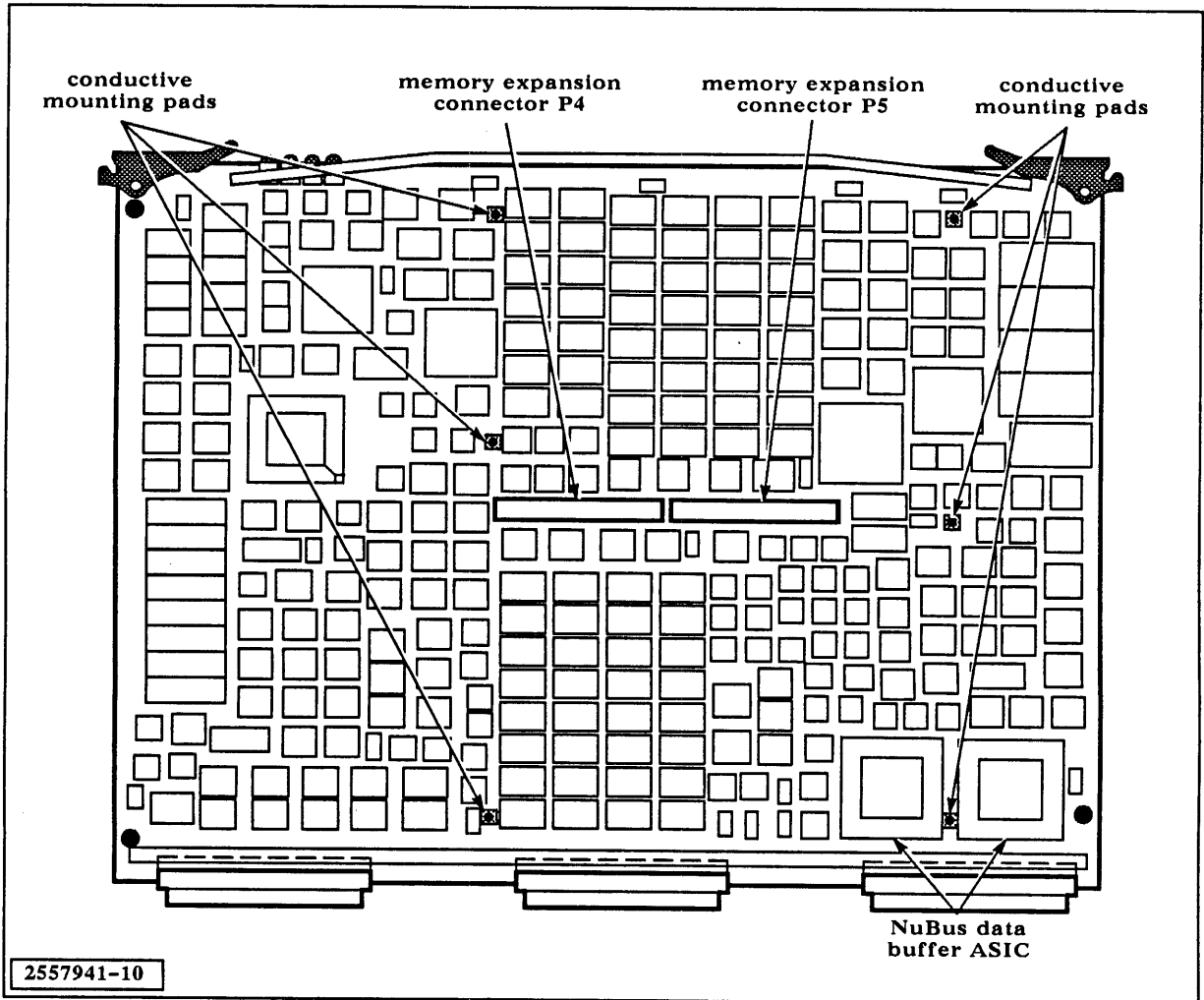
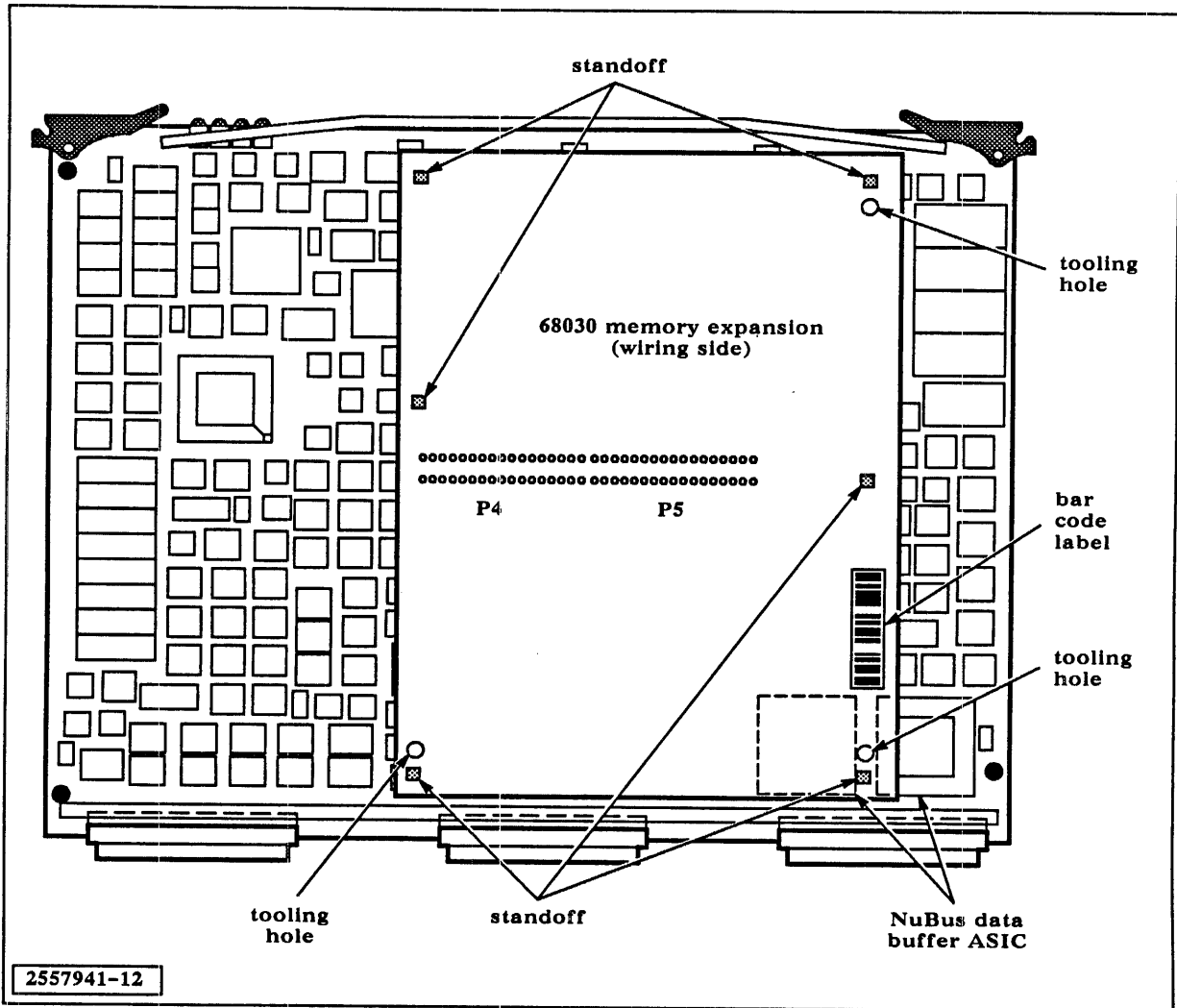

Figure 3-3 Memory Expansion Mounted on the Processor Board



**Installing the Processor Board**

3.4.2 To install the 68030 symmetric processor board, observe all safety warnings and cautions while performing the following steps:

1. Remove the processor board from its antistatic shipping bag and place it on an antistatic surface.
2. Remove power from the system enclosure as described in the part of *Computer Enclosure Installation and Operation* that applies to your system enclosure.

---

**WARNING:** To eliminate the possibility of electrical shock during option or upgrade installation, you must isolate the system enclosure from all potential energy sources. To isolate the system enclosure:

1. Power off the system enclosure and all peripherals.
  2. Disconnect the power cable from the wall outlet of all local peripherals connected to the system enclosure.
  3. Disconnect all interface cables between the system enclosure and all remote peripherals.
  4. Unplug the system enclosure power cable from the wall outlet.
- 

3. Gain access to the system enclosure card cage as described in *Computer Enclosure Installation and Operation*.
  4. Select the NuBus slot location using the processor slot location conventions that apply to your system. Slot conventions for System 1000 Series, System 1500 computer systems appear in *Computer Enclosure Installation and Operation*.
  5. Install the processor board in the selected slot, following the instructions for Eurocard circuit board installation. If the processor includes the piggyback memory expansion, take care not to snag the memory expansion board or its insulating shield on an adjacent logic board.
  6. Record the slot location and secure the card cage door or cover.
  7. If the processor does not require the SPA or if the SPA is already installed in the slot position, close the system enclosure and return the system to operation. To install the SPA, go on to the next paragraph.
- 

### Installing the SPA

**3.4.3** Each system enclosure must have one SPA to enable the booting and execution of the TI System V operating system software. A password embedded in the SPA must match a password embedded in the TI System V operating system to verify that the software is installed on a properly-licensed machine.

The SPA serves a second purpose, as a cable adapter that connects the processor board to the system maintenance terminal (SMT). The SMT is a limited-purpose terminal that is used by the system administrator in the initial boot of the system software and for running the disk-resident diagnostics.

The SPA must go on the backplane at connector P2 of the slot that holds the processor that boots TI System V. For a system with one processor board, the SPA attaches on the backplane at P2 of whatever slot contains the processor board.

In a multiprocessor system, processors arbitrate for the right to be the system test boot master (STBM) that controls both the SMT and the boot process. By convention, the processor in the lowest-numbered slot will win the arbitration and become the STBM. Therefore, the SPA goes in P2 of the lowest-numbered slot that holds a TI System V processor.

---

**NOTE:** Do not attempt to install the SPA in any slot that contains an Explorer, Explorer II™, Explorer II Plus™, or other Explorer-family symbolic processor. The SPA works only with numeric processors that execute TI System V in a System 1000 Series, System 1500 or Explorer LX computing system.

---

Each SPA has an ID number located on the SPA board protective cover (Figure 3-4). Record the SPA ID number from the SPA label. You will need the SPA ID number and the sales order number if you ever have to purchase a replacement SPA from Texas Instruments. Additional information on the SPA and SPA password appears in the *System Operation* manual.

To install the SPA, perform the following steps:

1. Remove the SPA from its antistatic shipping bag and place it on an antistatic surface.
2. Remove power from the system enclosure as described in the part of *Computer Enclosure Installation and Operation* that applies to your system enclosure.

---

**WARNING:** To eliminate the possibility of electrical shock during option or upgrade installation, you must isolate the system enclosure from all potential energy sources. To isolate the system enclosure:

1. Power off the system enclosure and all peripherals.
  2. Disconnect the power cable from the wall outlet of all local peripherals connected to the system enclosure.
  3. Disconnect all interface cables between the system enclosure and all remote peripherals.
  4. Unplug the system enclosure power cable from the wall outlet.
- 

3. Refer to the *Computer Enclosure Installation and Operation* manual for instructions on gaining access to the rear of the backplane. Locate P2 of the slot containing the processor board. In a multiprocessor system, select the lowest-numbered slot that contains a processor board.
4. Position the SPA so that the shield faces to the left, the 96-pin connector faces toward the backplane, and the two 18-pin cable ports are at the top of the SPA, facing out from the backplane.
5. Slide the SPA into the mounting rails until it is seated in the backplane P2 connector.
6. Install the SMT cable in the SPA port, following the instructions in the next paragraph.

Explorer II and Explorer II Plus are trademarks of Texas Instruments Incorporated.

**Installing the  
SMT Cable**

3.4.4 The following procedure describes direct cabling from the SPA to a local video display terminal (VDT) or to a modem for communication with a remote SMT. If your system includes the diagnostic panel with local/remote switching, refer to the 16-slot computer enclosure description in *Computer Enclosure Installation and Operation* for diagnostic panel cabling information.

The SMT cable provides an interface between the SPA and the SMT. The lower cable connector on the SPA supports a baud rate of 1200 and is used when connecting the SPA to a modem for remote location support and system boot operation. The upper cable connector on the SPA supports a baud rate of 9600 and is used to connect a local video display terminal (VDT). To install the SMT cable, proceed as follows:

1. Verify that power is off the system enclosure and peripherals and that the ac power cord is removed from the system enclosure.
2. Gain access to the the rear of the backplane as described in *Computer Enclosure Installation and Operation*.
3. Route the 18-pin connector of the SMT cable to the SPA.
4. Attach the 18-pin cable connector to the port corresponding to the speed of the device you are installing, as follows:
  - Upper port — 9600 bits per second (local console)
  - Lower port — 1200 bits per second (modem)

---

**NOTE:** The system supports only one SMT. Do not connect more than one cable to the SPA at a time unless the system enclosure includes the diagnostic panel with SMT remote/local switching, as described in *Computer Enclosure Installation and Operation*.

---

5. Attach the other end of the cable to the appropriate VDT or modem.
6. Close the system enclosure and return the system to operation. Refer to *Terminal/Printer Information* and to the manual for your particular terminal for SMT setup data. Additional information on the system boot process appears in *System Operation* and in the TI System V documentation.

Figure 3-4

## Software Protection Adapter

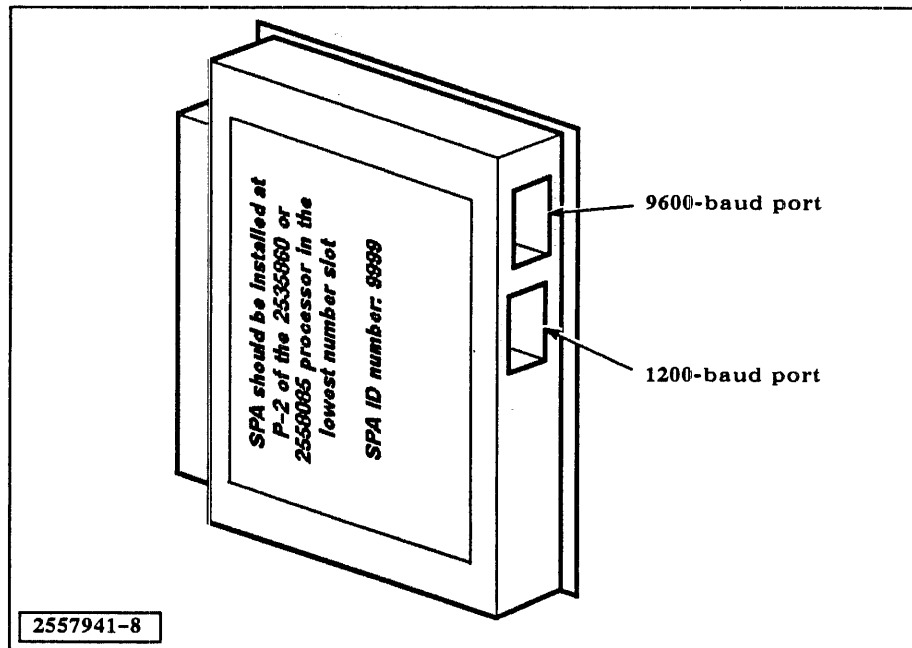

## LED Indicator Operation

3.5 Four LED indicators are located on the board edge, as shown in Figure 3-5. These indicators are:

- Green (top) — Programmable interval timer (PIT) overrun
- Yellow — Correctable memory error
- Red — Uncorrectable memory error
- Red (bottom) — Self-test/board fault

The green PIT overrun indicator remains on while the processor services normal PIT interrupts. The indicator remains on to indicate normal processor operation. The PIT overrun indicator may turn off momentarily as part of the power-up self-test and system boot process.

The yellow correctable memory error LED lights when the processor detects and corrects a single-bit read error in the on-board or expansion memory. The indicator latches on the first error, and does not clear until a reset occurs or a software command clears the latch. TI System V periodically reads the indicator status and clears the indicator latch. If the error log shows repeated errors, memory performance is deteriorating. Service personnel should run memory diagnostic tests to confirm the problem and detect the failing device.

The red uncorrectable memory error LED lights when any 2-bit read error occurs in on-board or expansion memory. The processor cannot correct the error automatically. If the error is the result of a memory read by a remote NuBus master, the processor informs the NuBus master via a status code at the end of the bus transfer. The uncorrectable error signal latches on the first uncorrectable error, and does not clear until a reset occurs or a software command clears the latch. If the indicator comes on at any time (except temporarily during self-test), service personnel should run memory diagnostic tests to confirm the problem and detect the failing device(s).

The red self-test/board fault LED lights at power-up and remains on until the self-tests complete successfully. The LED is controllable via a remote STBM processor or by the on-board 68030 processor.

Figure 3-5

---

**Processor Board LED Indicators**

---

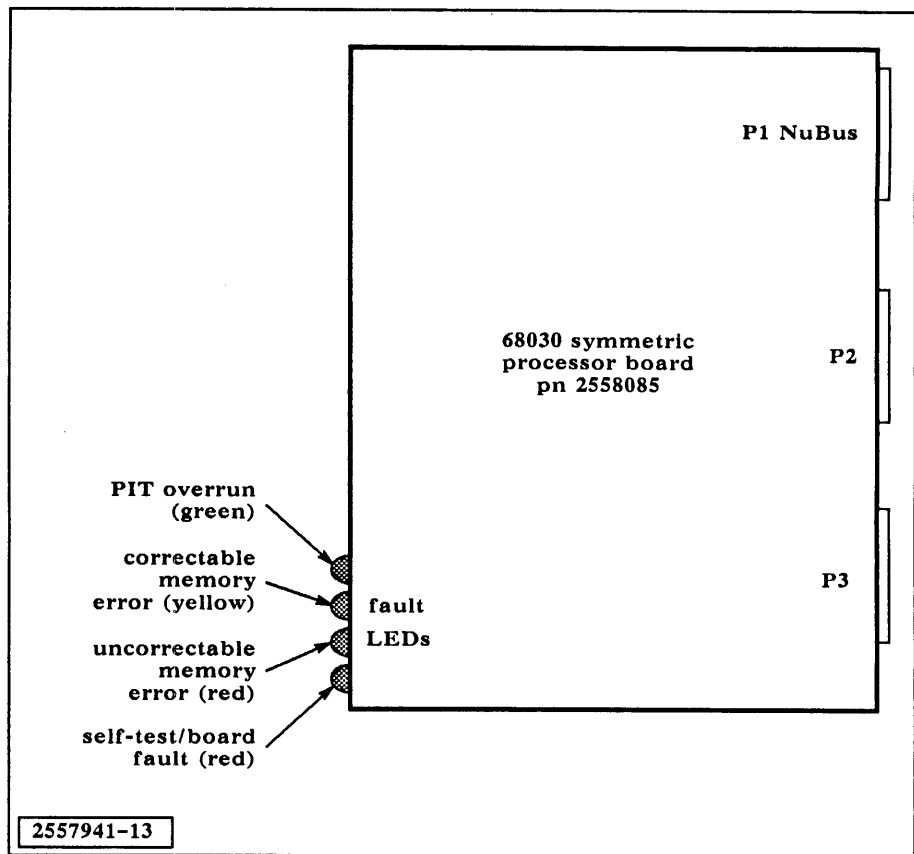



# INDEX

---

## B

### boards

configuration restrictions: 68030 3-1  
features: 68030 1-4-1-5  
general description: 68030 1-1  
installation: 68030 3-6-3-7  
reference documents: 68030 1-6  
shipping container: 68030 2-2  
specifications: 68030 1-5-1-6  
TI installation: 68030 3-2  
unpacking: 68030 2-1-2-3

## C

cautions, static electricity: 68030 2-1, 3-2

## E

electrical shock warning: 68030 3-7, 3-8

## F

features: 68030 1-4-1-5

## I

indicators, LED: 68030 3-10-3-11  
installation  
cautions: 68030 3-2  
memory expansion board: 68030 3-3-3-6  
processor board: 68030 3-6-3-7  
software protection adapter (SPA): 68030  
3-7-3-8  
system maintenance terminal cable: 68030  
3-9-3-10  
warnings: 68030 3-7, 3-8

## L

LED indicators: 68030 3-10-3-11

## M

memory expansion board  
general description: 68030 1-3  
installation: 68030 3-3-3-6  
TI installation: 68030 3-2

## P

### processor board

configuration restrictions: 68030 3-1  
features: 68030 1-4-1-5  
figure: 68030 1-2  
general description: 68030 1-1  
installation: 68030 3-6-3-7  
reference documents: 68030 1-6  
software protection adapter (SPA): 68030  
1-4  
specifications: 68030 1-5-1-6

## R

reference documents: 68030 1-6  
restrictions, configuration: 68030 3-1

## S

### shipping container

SPA: 68030 2-3  
system board: 68030 2-2  
software protection adapter (SPA)  
installation: 68030 3-7-3-8  
shipping container: 68030 2-3  
TI installation: 68030 3-2  
specifications: 68030 1-5-1-6  
static electricity caution: 68030 2-1, 3-2  
system boards. *See* boards  
system maintenance terminal (SMT), cable  
installation: 68030 3-9-3-10

## T

### TI-installation

memory expansion board: 68030 3-2  
software protection adapter (SPA): 68030  
3-2  
system boards: 68030 3-2

## U

### unpacking

cautions: 68030 2-1  
system boards: 68030 2-1-2-3

## W

warnings, electrical shock: 68030 3-7, 3-8

**68040MP  
PROCESSOR**

---

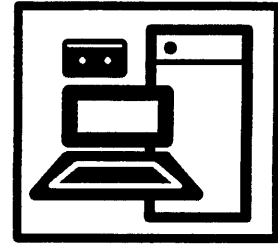



# CONTENTS

---

Paragraph	Title	Page
<b>1</b>	<b>68040MP Processor Introduction</b>	
1.1	Introduction .....	1-1
1.2	Features .....	1-4
1.3	Specifications .....	1-5
1.4	Reference Documents .....	1-6
<b>2</b>	<b>68040MP Processor Unpacking</b>	
2.1	Introduction .....	2-1
2.2	Unpacking .....	2-1
<b>3</b>	<b>68040MP Processor Installation and Operation</b>	
3.1	Introduction .....	3-1
3.2	Configuration Restrictions .....	3-1
3.3	Arranging for TI Installation .....	3-2
3.4	Installation Procedures .....	3-2
3.4.1	Installing the Memory Expansion .....	3-3
3.4.2	Installing the Processor Board .....	3-5
3.4.3	Installing the SPA .....	3-6
3.4.4	Installing the SMT Cable .....	3-8
3.4.5	Installing the LAN/SCSI Adapter .....	3-10
3.4.6	Connecting an External SCSI Device .....	3-12
3.4.7	Connecting an Ethernet LAN to the AUI Connector .....	3-14
3.4.8	Connecting an Ethernet LAN to the BNC Connector .....	3-16
3.5	LED Indicator Operation .....	3-18

---

## Index

	Figure	Title	Page
<b>Figures</b>	1-1	68040MP Processor .....	1-2
	1-2	68040MP Memory Expansion Board .....	1-3
	1-3	Software Protection Adapter .....	1-3
	1-4	LAN/SCSI Adapter .....	1-4
	2-1	System Board Shipping Container .....	2-2
	2-2	Typical Cable Adapter Shipping Container .....	2-3
	3-1	68040MP Processor, Memory Expansion, SPA, and LAN/SCSI Adapter .....	3-3
	3-2	Memory Expansion Mounting Provisions on the Processor Board .....	3-4
	3-3	Memory Expansion Mounted on the Processor Board .....	3-5
	3-4	SPA Identification Label .....	3-8
	3-5	68040MP Processor, Memory Expansion, SPA, and Cabling .....	3-9
3-6	LAN/SCSI Adapter .....	3-10	
3-7	Connecting an External SCSI Device .....	3-12	
3-8	SCSI Champ Terminator and MSU Cable Adapter .....	3-13	
3-9	Connecting the AUI Connector to the end of an Existing Ethernet LAN .....	3-1	
3-10	Connecting the AUI Connector to the end of an existing Thin Ethernet LAN .....	3-17	
3-11	Processor Board LED Indicators .....	3-18	

	Table	Title	Page
<b>Table</b>	1-1	68040MP Processor Specifications .....	1-5

# 68040MP PROCESSOR INTRODUCTION

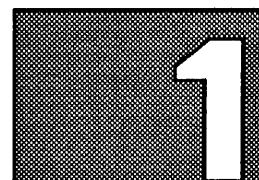

---

## Introduction

**1.1** This section provides an introduction to the 68040MP processor board, the 68040MP memory expansion, the software protection adapter (SPA), and the LAN/SCSI adapter. This information is organized into three major topics:

- Features
- Specifications
- Reference documents

The 68040MP processor (Figure 1-1) is an advanced general-purpose processor for use in single processor and multiprocessor computing systems based on the NuBus™ high-speed data bus. The 68040MP processor provides significant performance improvements over both the original 68020-based System 1500 processor and the 68030-based System 1500 processor, and serves as the basis for high-performance models System 1500 Computer. Several application-specific integrated circuits (ASICs) provide superior functionality. Through the use of memory expansion boards and the use of ASICs, space requirements on the processor board have been reduced and additional functions have been added to the processor assembly. Located on the 68040MP processor assembly is a SCSI Bus controller and a high-performance LAN 802.3 Ethernet controller.

Dynamic random-access memory (DRAM) chips on the piggyback memory expansion (Figure 1-2) provide local storage for processor data and instructions. Error-checking and correcting (ECC) logic protects the expansion memories. Cache memory provides high-speed memory access for enhanced performance.

The SPA (Figure 1-3) provides a hardware identification number for correlation with a software password required by TI System V operating system software. The SPA provides terminal connections for a system maintenance terminal (SMT), and must be installed on the processor that serves as the system test boot master (STBM).

The on-board SCSI Bus controller, with the addition of the LAN/SCSI adapter, provides a high performance SCSI interface that maximizes data throughput and minimizes command processing overhead. The MC68010 microprocessor provides bus control, status, and data transfer operations for a maximum of seven mass storage devices on the SCSI bus.

The high performance LAN controller provides a single-channel interface between the host computer and a local area network (LAN). A switch located on the LAN/SCSI adapter assembly allows the LAN controller to be configured to support either the IEEE 802.3 Ethernet (AUI) or the IEEE 802.3a Cheapernet (BNC) standard.

NuBus is a trademark of Texas Instruments Incorporated.

The LAN/SCSI adapter, Figure 1-4, is a peripheral cable adapter board connecting to connector P3 on the backplane of the slot containing the 68040MP processor assembly. It provides for either an AUI or BNC LAN connection, as well as a SCSI bus controller to support external SCSI mass storage devices. Located on the lower left edge of the adapter is the switch used to select AUI or BNC.

Figure 1-1 68040MP Processor

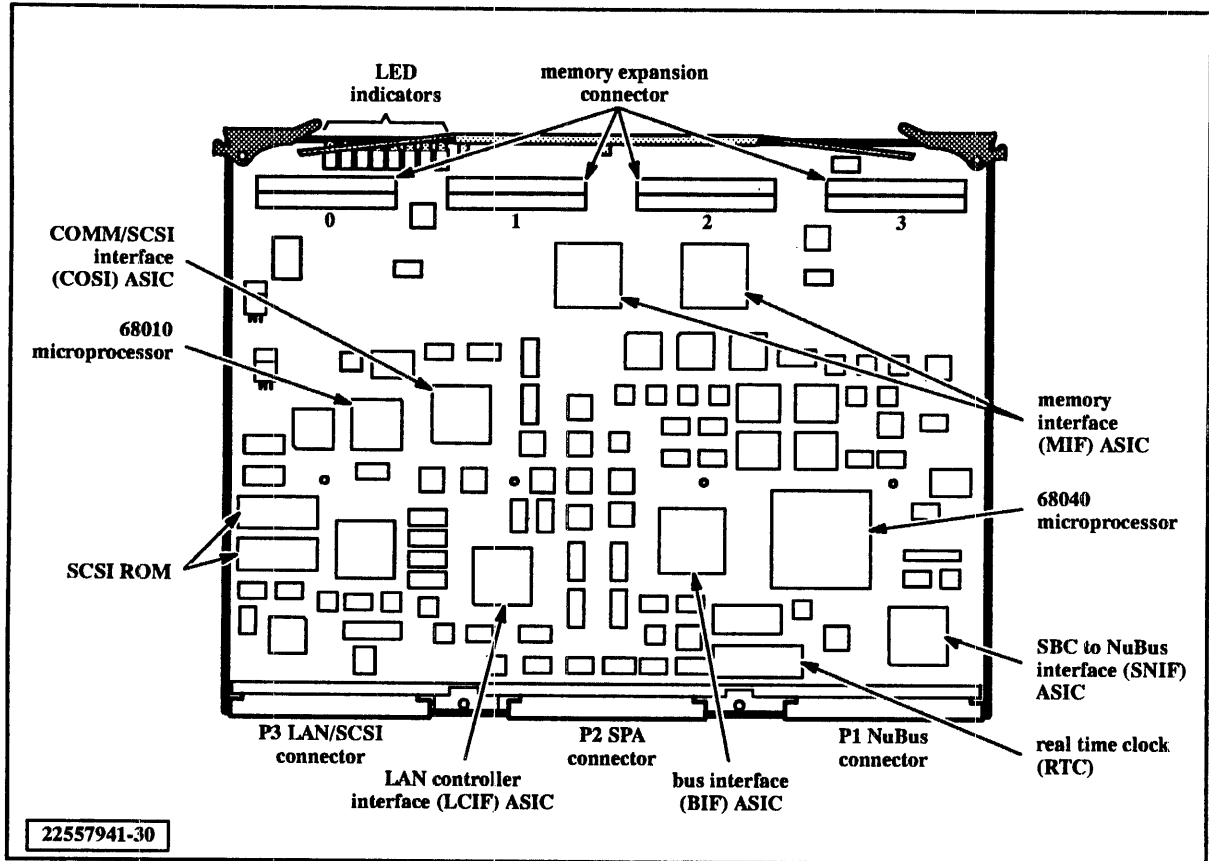

Figure 1-2

68040MP Memory Expansion Board

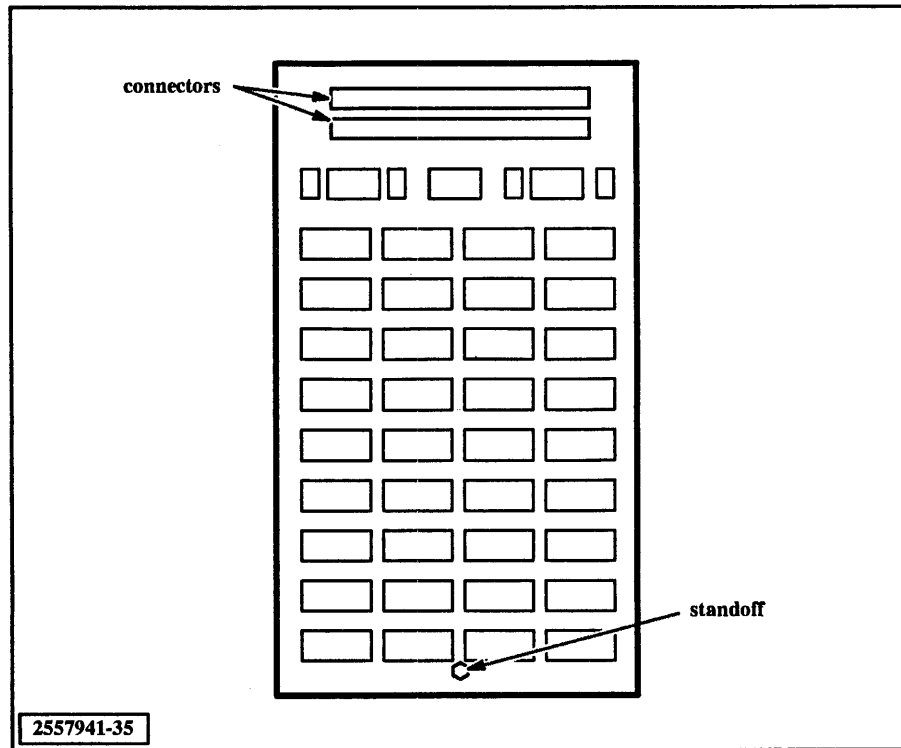

Figure 1-3

Software Protection Adapter

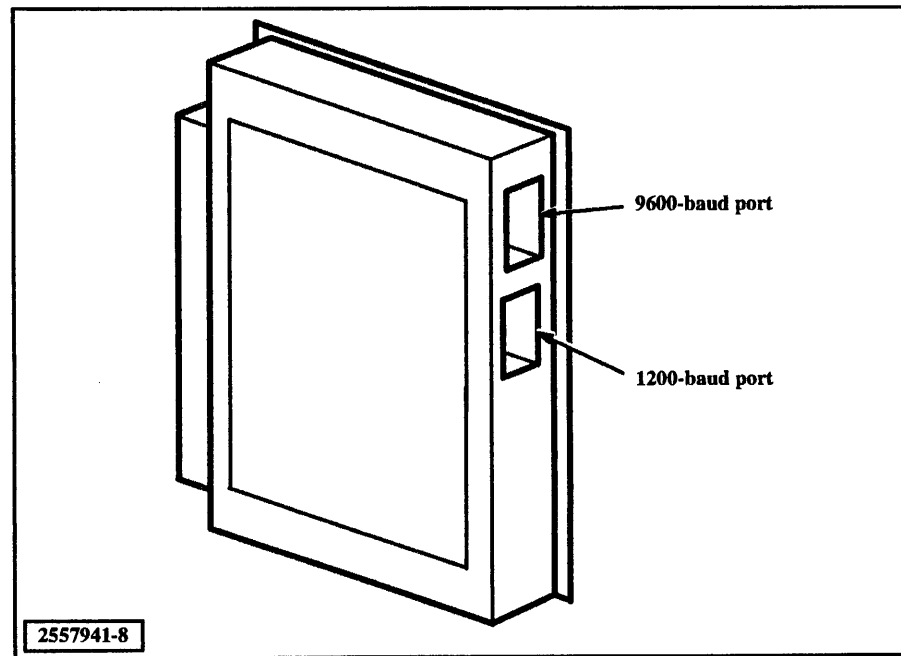
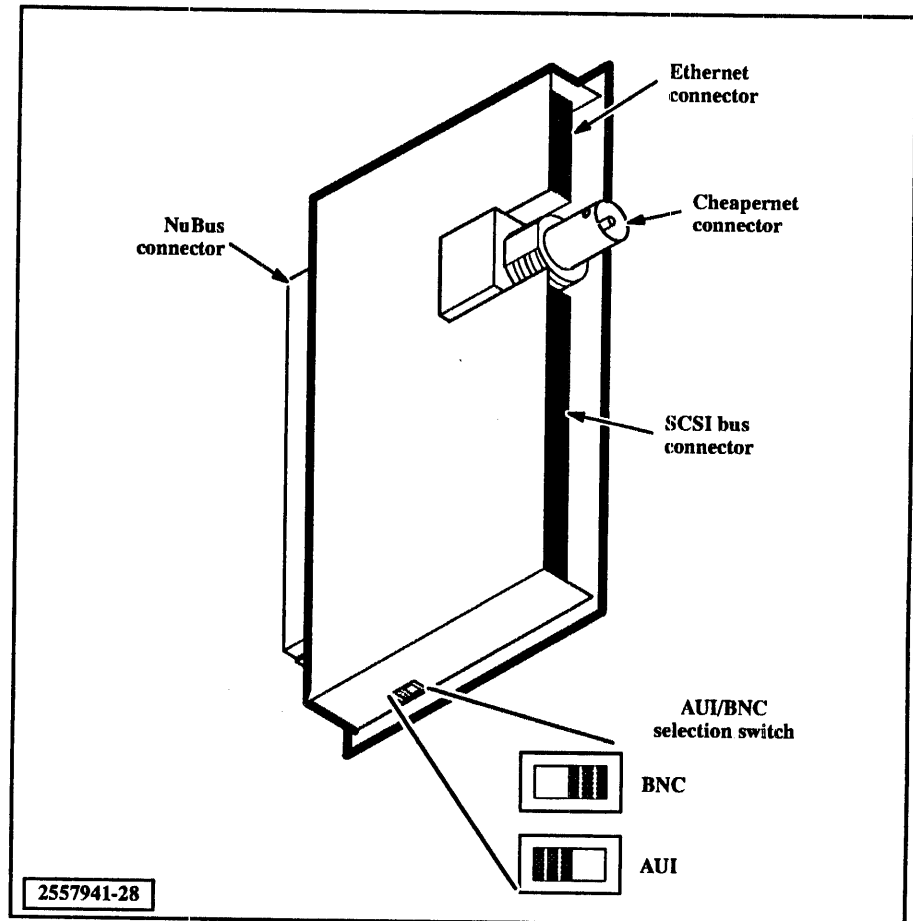



Figure 1-4

## LAN/SCSI Adapter



## Features

1.2 The 68040MP processor assembly provides a number of features that enhance system performance. Key features of the 68040MP processor include the following:

- The virtual memory system allows the microprocessor to access the full 4-gigabyte address space without regard to the much smaller amount of physical memory available. The demand-paged memory management scheme moves fixed-size pages of data between memory and mass storage disk drives.
- The 68040 enhanced 32-bit microprocessor, operating at 33.3 megahertz, serves as the central processor, bus controller, and memory management unit. The 68040 includes instruction pipeline logic, data and instruction cache memories, and other enhancements for high-speed operation.
- 128-kilobyte cache memory provides high-speed access to often-used data and instructions.
- Memory expansion boards, using 4-megabit DRAM devices, provide 32- to 128-megabytes of main memory. ECC logic protects against memory errors.

- Dual-bus architecture separates shared resources from processor-only resources, allowing overlap of microprocessor local bus cycles and NuBus input/output cycles.
- Nonvolatile random-access memory (NVRAM) with an internal battery provides storage for system configuration parameters.
- Read-only memory (ROM) stores permanent board information and self-test programs.
- The interrupt controller internal to the Bus Interface ASIC (BIF) handles board interrupts and NuBus events.
- Timers provide time accounting, interval measurement, and a battery-maintained real-time clock (RTC).
- The NuBus interface includes 16-word first-in, first-out (FIFO) buffers to maintain optimum data flow between the NuBus and the processor board.
- The on board LAN controller supports the IEEE 802.3 Ethernet (AUI) and the IEEE 802.3a Cheapernet (BNC) LAN standards.
- The on board SCSI bus controller supports the SCSI-2 interface standard and supports fast device reads up to 10 megabytes per second.

---

## Specifications

1.3 Table 1-1 lists the hardware specifications of the 68040MP processor board.

**Table 1-1**

---

### 68040MP Processor Specifications

---

Item	Specifications
Form factor	Triple-height Eurocard, with connectors and mounting provisions for piggyback 68040MP memory expansion
Main memory	32 to 128 megabytes of ECC-protected DRAM using one to four memory expansion boards
Error checking	Parallel ECC logic detects and corrects all single-bit errors and detects all 2-bit errors
Cache memory	132-kilobyte cache memory using 20-nanosecond static RAM devices with parity protection
Addressing	8 megabytes accessible at the NuBus slot address, Fs000000. All memory accessible via a loadable base register that biases the on-board and expansion memory into NuBus global address space
NuBus slave operation	Supports NuBus slave reads or writes (8-bit bytes, 16-bit halfwords, or 32-bit words) from external master to memory or physical bus registers. Accepts NuBus slave block transfers of 32-bit words.

Table 1-1

68040MP Processor Specifications (Continued)	
Item	Specifications
NuBus master operation	Reads or writes external slaves in bytes, halfwords, or words. The SCSI controller performs NuBus block transfers as a master; however, the CPU performs only single transfers.
SCSI bus controller	SCSI-2 Controller, SCSI reads of 10 megabytes per second
LAN interface	
CPU Clock rate	33.3-megahertz processor clock
Power	
Processor	+5 volts, 12.0 amperes +12 volts, 0.04 amperes -12 volts, 0.02 amperes
Memory Expansion	+5 volts, 1.2 amperes
Temperature	
Operating	10° to 35° C (50° to 95° F)
Nonoperating	-40° to 65° C (-40° to 149° F)
Wet bulb	27° C (80° F) maximum
Relative Humidity	
Operating	20% to 80% (noncondensing)
Nonoperating	5% to 95% (noncondensing)

## Reference Documents

1.4 For additional technical information on the 68040MP processor and its application in different computing systems, refer to the following documents:

- *IEEE Standard for a Simple 32-Bit Backplane Bus: NuBus*, IEEE Standard 1196-1987, (Institute of Electrical and Electronics Engineers, Inc.)
- *NuBus System Architecture General Description*, TI part number 2537171-0001
- *IEEE Standard for Binary Floating-Point Arithmetic*, ANSI/IEEE Standard 754-1985, (Institute of Electrical and Electronics Engineers, Inc.)
- *TI System V Administrator's Guide*, TI part number 2540539-0001
- *NuBus Systems System 1500 Field Maintenance*, TI part number 2549258-0001

# 68040MP PROCESSOR UNPACKING

---

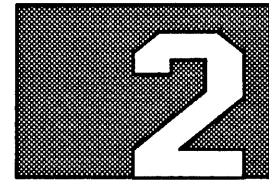

## Introduction

2.1 This section describes how to unpack and handle the 68040MP processor, the 68040MP memory expansion, software protection adapter (SPA), and the LAN/SCSI adapter.

The 68040MP processor kit is packed in a system board shipping container (Figure 2-1). If you purchased a memory expansion, the board is packed in the same way as the processor, in a smaller box. The SPA and the LAN/SCSI adapter are each packed in cable adapter shipping containers (Figure 2-2).

---

## Unpacking

2.2 System owners who install their own system boards should perform the following steps to unpack the equipment:

1. Visually inspect the shipping container for damage. If the inspection reveals damage to the shipping container, contact the carrier agent for instructions on filing a claim. The carrier, not Texas Instruments, is responsible for damage during shipment. Resolve all problems relating to shipping damage before proceeding with the installation.
2. Note on the delivery receipt any problems that you discover.
3. Be sure that the driver has signed the delivery receipt.
4. Obtain a knife for cutting the sealing tape that secures the system board and the cable adapter packing containers.

---

**CAUTION:** The processor, memory expansion, SPA, and LAN/SCSI adapter circuit boards contain static-sensitive electronic components. To avoid damage to these components, ensure that you are well grounded before handling the circuit boards.

The recommended method is to use a static-control system consisting of a static-control floor or table mat and a static-control wrist strap. These are commercially available. If you do not have a static-control system, you can discharge any accumulated static charge by touching a grounded object prior to handling the circuit board.

Before storing or transporting any circuit board, return it to its protective antistatic package.

---

5. As you unpack the processor and expansion memory (Figure 2-1), the SPA, or the LAN/SCSI adapter (Figure 2-2) inspect the equipment for shipping damage. If the inspection reveals damage that you feel is significant, stop the unpacking procedure and contact the carrier agent. After the carrier agent inspects the damage, contact a Texas Instruments Field Service office. Save all the packing material for future use whenever possible.

Figure 2-1

System Board Shipping Container

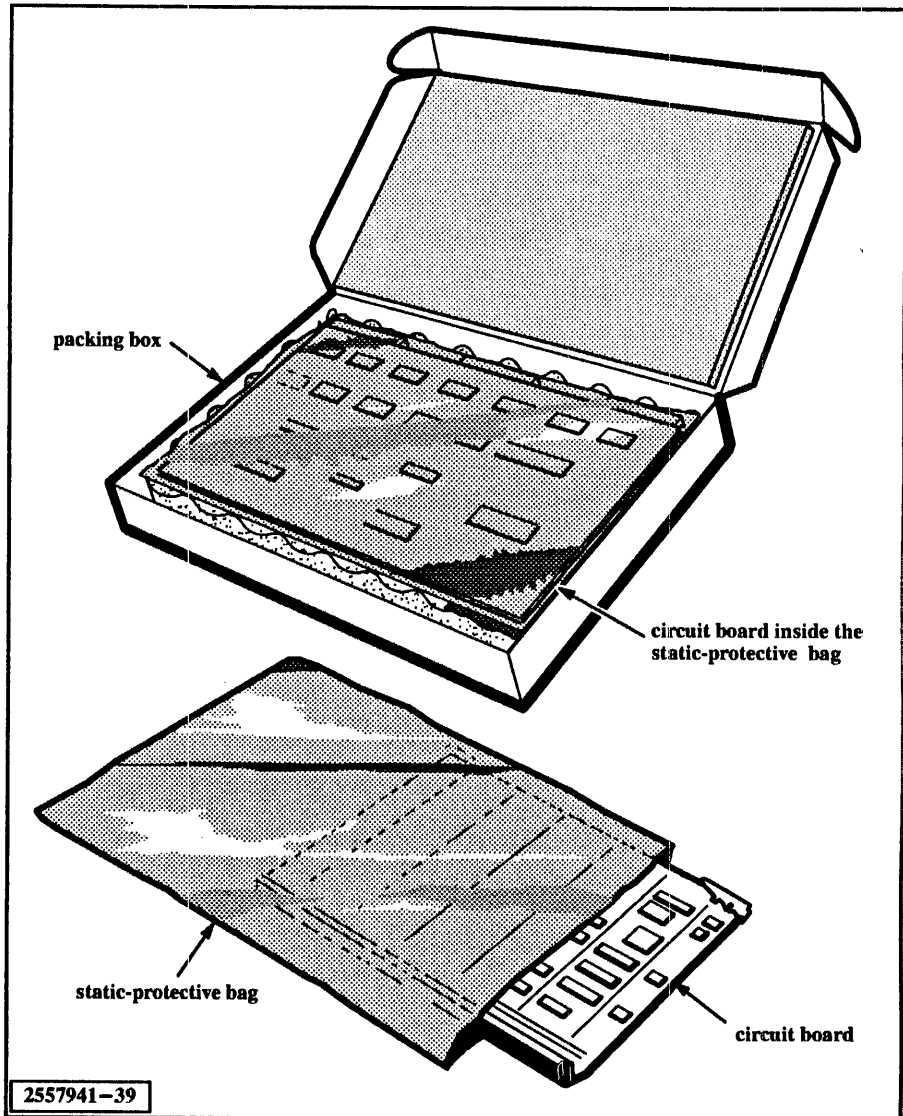
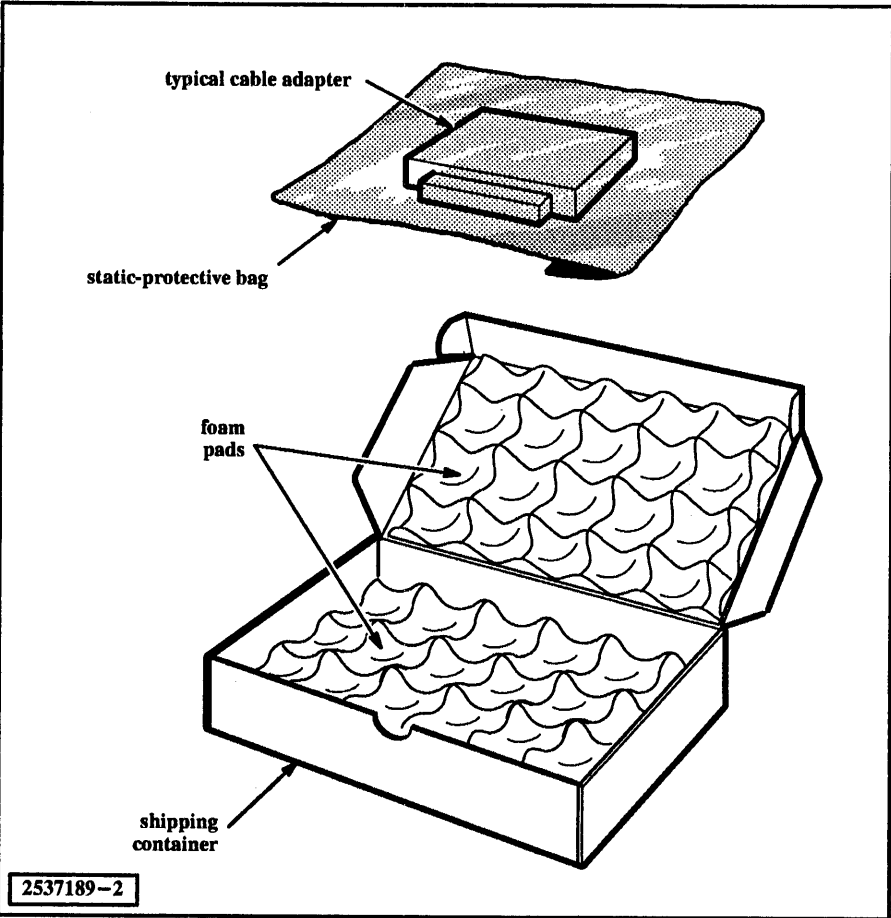
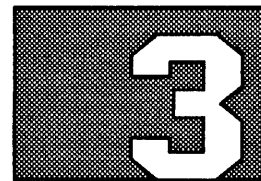

Figure 2-2

Typical Cable Adapter Shipping Container



# 68040MP PROCESSOR INSTALLATION AND OPERATION



---

## Introduction

**3.1** This section provides information on installation and operation of the 68040MP processor, the piggyback 68040MP memory expansion, the software protection adapter (SPA), and the LAN/SCSI adapter. The installation instructions apply to situations where you are adding the processor and/or memory expansion to an existing computer system. If you purchase a new computer system that includes these components, Texas Instruments installs them at the factory.

If you purchase the processor and/or memory expansion to upgrade an existing system, you have the option of installing the boards yourself or having Texas Instruments perform the installation for you.

---

## Configuration Restrictions

**3.2** There are hardware and software restrictions that apply to the installation and operation of the 68040MP processor. These restrictions may change with hardware changes and software releases. Unless you are replacing an existing 68040MP processor, you should know about these restrictions. Present restrictions include:

- TI System V, release 3.3.1 (or a later release) is required to support the 68040MP processor. Systems with multiple processors require the extended symmetric processing (ESP) license for the TI System V operating system software.
- GDOS, release 2.9 (or a later release) is required to support the 68040MP processor.
- The 68040MP processor is not compatible with the original 7-slot chassis with local bus backplane shipped with early Explorer™ or Explorer LX™ systems. It is compatible with the NuBus-only backplanes shipped in production models of the System 1000 Series, System 1500 computing systems.
- Multiprocessor systems may include a mix of 68040MP processors, 68030 processors, and 68020 processors. However, some early-production 68020 processors are incompatible with 68040MP processors, 68030 processors, and with later-production 68020 processors. Part numbers of the fully-compatible 68020 processors are:
  - 2535860-0001 (rev. AN or any later revision level)
  - 2535860-0002 (all revision levels)
- The processor board in the lowest-numbered NuBus slot serves as the system test boot master (STBM). If your system includes a mix of processor types, install a 68040MP processor (and SPA) in slot 0 for fastest system boot time.
- The Ethernet controller on the 68040MP does not support TI's network terminal concentrators (NTCs).

Explorer and Explorer LX are trademarks of Texas Instruments Incorporated.

---

**Arranging for  
TI Installation**

**3.3** The following procedure outlines the tasks you must perform before TI installs your processor board, memory expansion, SPA, or LAN/SCSI adapter:

1. Note the serial number from the original system documents or from the box that contained this manual.
2. Call the Field Service Communications Center (FSCC) at telephone number 1-800-572-3300 to schedule a site inspection (if required) and the equipment installation. Refer to your system installation manual for site requirements. The following information is required to schedule a TI installation:
  - System serial number
  - Customer name
  - Customer street address, city, state, and zip code
  - Name and telephone number of customer personnel to contact
  - Purchase order number if the installation was not ordered with the equipment

---

**Installation  
Procedures**

**3.4** Processor installation is divided into four parts: mounting the memory expansion on the processor, installing the processor in the system enclosure, installing the SPA, and installing the LAN/SCSI adapter. Figure 3-1 shows the relationship between the processor, the memory expansion, the backplane, the SPA, and the LAN/SCSI adapter.

---

**CAUTION:** All boards, options, adapters, and peripherals contain components that are sensitive to static electricity. When handling any of these items, protect against static electricity by using wrist grounding straps, grounded working mats, and antistatic bags for moving or storing the items.

---



Figure 3-1

## 68040MP Processor, Memory Expansion, SPA, and LAN/SCSI Adapter

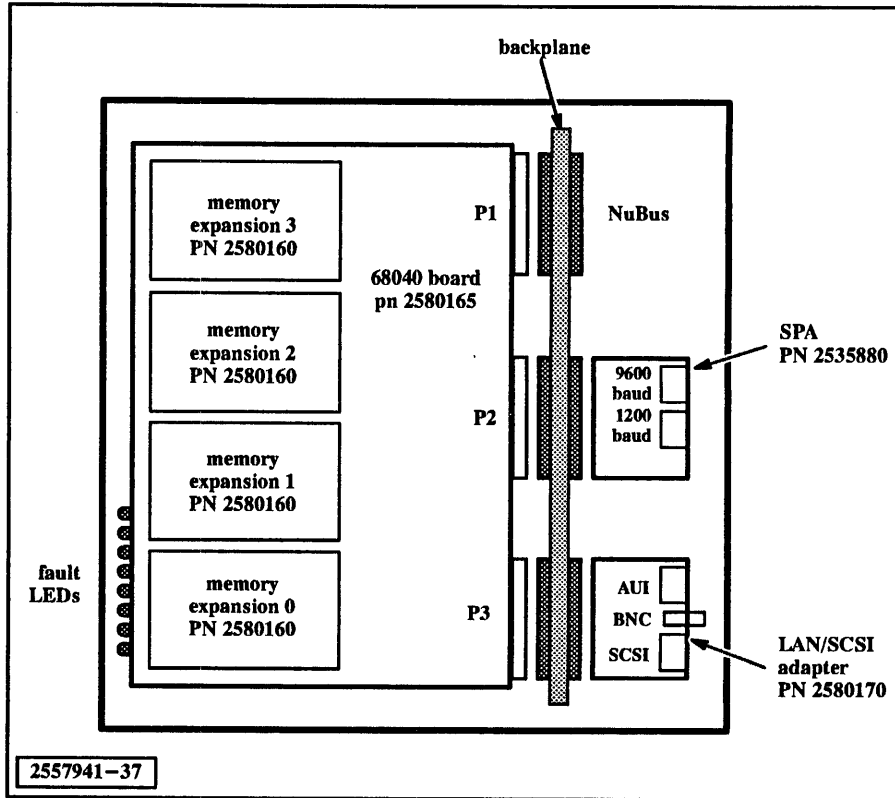

### Installing the Memory Expansion

**3.4.1** Up to four 68040MP memory expansion boards can be mounted piggyback on the 68040MP processor board, not requiring additional NuBus slots. These boards are not compatible with the 68020 processor or the 68030 processor, and the board size and connector scheme are different to prevent confusion. At least one memory expansion board is required, and it must be installed at location 0, with additional memory boards installed in locations 1, 2, and 3 respectively.

A memory size code hardwired on the memory expansion notifies the processor of the presence and amount of additional memory. Kit and board level part numbers for the different capacity memory expansion boards are:

Kit Part Number	Board Part Number	Memory Capacity
2580277-0001	2580160-0002	16 megabytes
2580278-0001	2580160-0001	32 megabytes

The 68040MP memory expansion boards have two 100-pin female connectors located at one end of the board. These female connectors mate with the male connectors located near the edge of the processor board. There are four pairs of male connectors on the 68040MP processor board. The location of each pair is numbered. The first memory expansion board must be installed at location 0, while additional memory boards should be installed at locations 1, 2, and 3, respectively. A metal standoff on the expansion board mounts on the processor board.

To install a memory expansion board on the 68040MP processor board, refer to Figure 3-2 and Figure 3-3, and perform the following procedure:

1. Observe all antistatic and board-handling precautions.
2. Remove the processor board from the system enclosure or its antistatic shipping bag, and place it on an antistatic surface. Remove the memory expansion board from its antistatic shipping bag.
3. Position the expansion board, connector side down, over the lowest numbered available expansion location on the processor board, aligning the two 100-pin connectors.
4. Gently press the expansion board connectors onto the processor board connectors. Do not force the connectors. If the connectors bind, carefully lift the expansion board and check the processor board connectors for bent pins. If a pin is bent, proceed as follows:
  - a. With a pair of long-nose pliers, carefully straighten the bent pin.
  - b. Try again to install the memory expansion board.
5. Carefully thread the provided 4-40 machine screw from the back side of the processor and into the base of the metal standoff. Use care not to cross-thread the machine screw.
6. With a 3/16 inch nut driver, secure the mounting screw firmly without over-tightening it.
7. Install the upgraded processor board in the enclosure card cage as described in the next paragraph.

Figure 3-2

**Memory Expansion Mounting Provisions on the Processor Board**

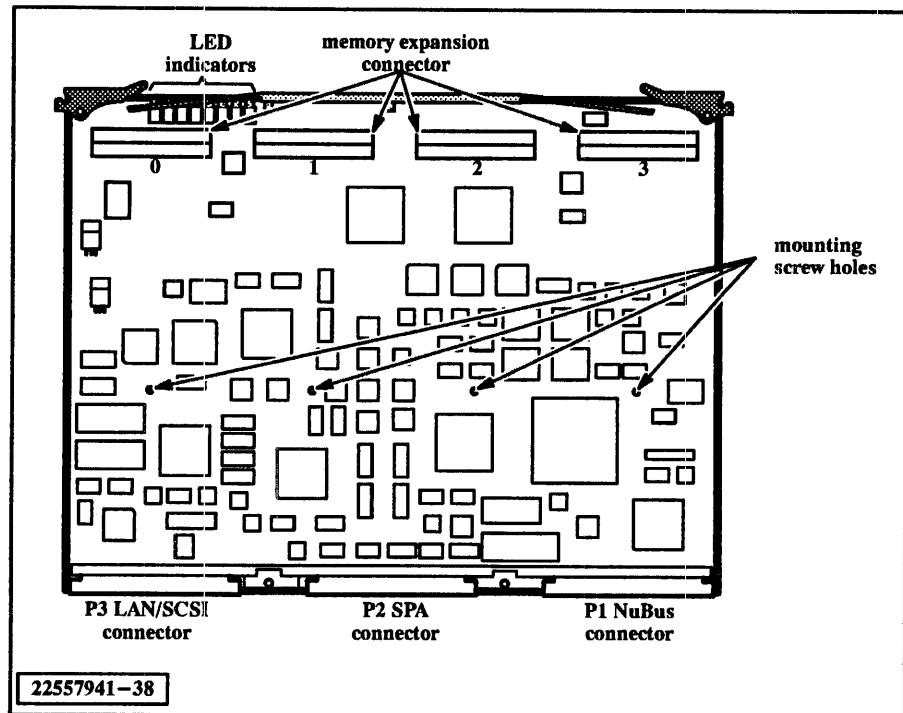
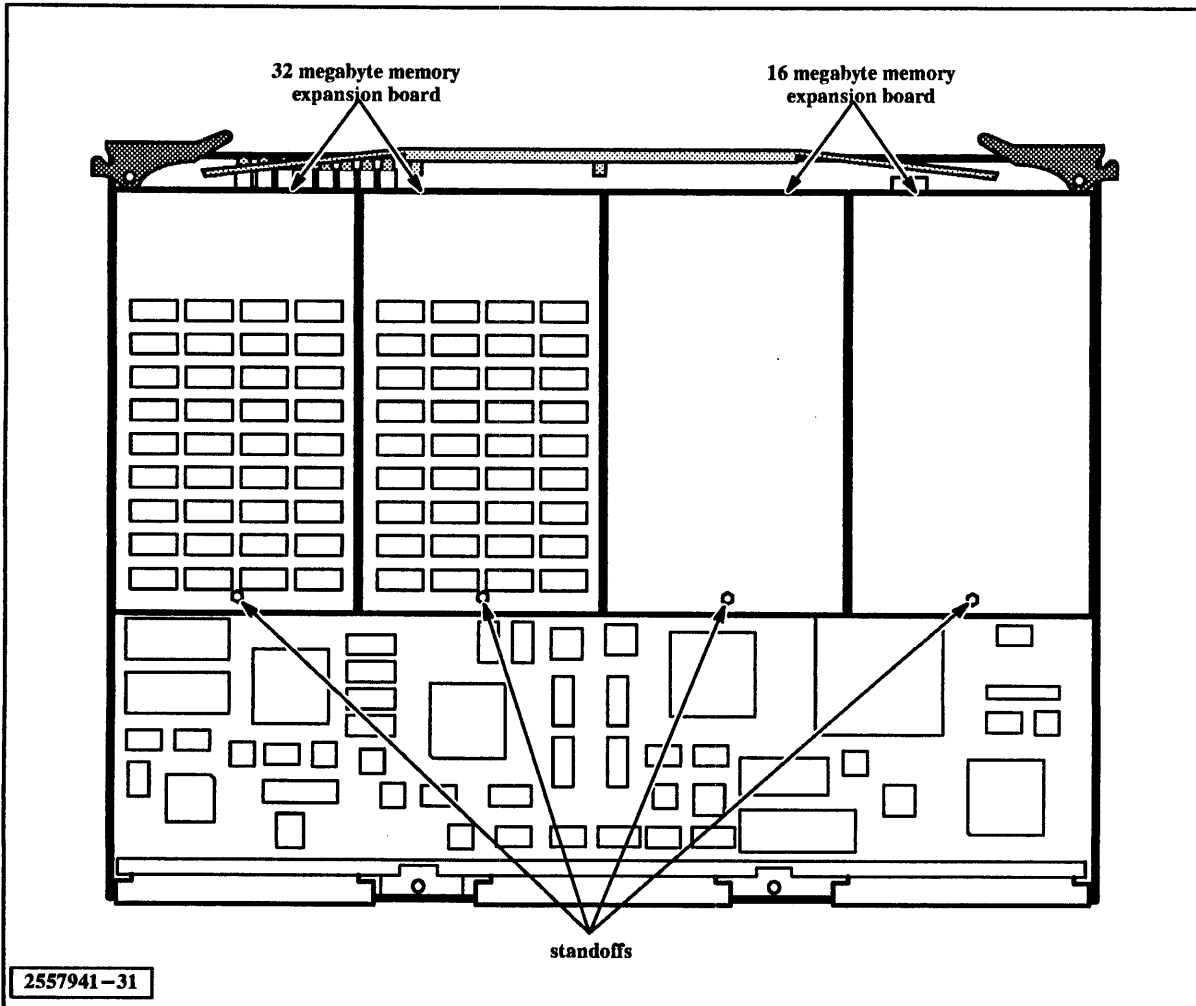

Figure 3-3 Memory Expansion Mounted on the Processor Board



#### Installing the Processor Board

3.4.2 To install the 68040MP processor board, observe all safety warnings and cautions while performing the following steps:

1. Remove the processor board from its antistatic shipping bag and place it on an antistatic surface.

2. Remove power from the system enclosure as described in the part of *Computer Enclosure Installation and Operation* that applies to your system enclosure.

---

**WARNING:** To eliminate the possibility of electrical shock during option or upgrade installation, you must isolate the system enclosure from all potential energy sources. To isolate the system enclosure:

1. Power off the system enclosure and all peripherals.
  2. Disconnect the power cable from the wall outlet of all local peripherals connected to the system enclosure.
  3. Disconnect all interface cables between the system enclosure and all remote peripherals.
  4. Unplug the system enclosure power cable from the wall outlet.
- 
3. Gain access to the system enclosure card cage as described in *Computer Enclosure Installation and Operation*.
  4. Select the NuBus slot location using the processor slot location conventions that apply to your system. Slot conventions for System 1000 Series, System 1500 computer systems appear in *Computer Enclosure Installation and Operation*.
  5. Install the processor board in the selected slot, following the instructions for Eurocard circuit board installation. Take care not to snag the memory expansion board(s) on an adjacent logic board.
  6. Record the slot location and secure the card cage door or cover.
  7. If the processor does not require the SPA or the LAN/SCSI cable adapter; or if they are already installed in the slot position, close the system enclosure and return the system to operation. If the SPA or cable adapter must be installed, refer to the following paragraphs.

### Installing the SPA

**3.4.3** Each system enclosure must have one SPA to enable the booting and execution of the TI System V operating system software. A password embedded in the SPA must match a password embedded in the TI System V operating system to verify that the software is installed on a properly-licensed machine.

The SPA serves a second purpose, as a cable adapter that connects the processor board to the system maintenance terminal (SMT). The SMT is a limited-purpose terminal that is used by the system administrator in the initial boot of the system software and for running the disk-resident diagnostics.

The SPA must go on the backplane at connector P2 of the slot that holds the processor that boots TI System V. For a system with one processor board, the SPA attaches on the backplane at P2 of whatever slot contains the processor board.

In a multiprocessor system, processors arbitrate for the right to be the system test boot master (STBM) that controls both the SMT and the boot process. By convention, the processor in the lowest-numbered slot will win the arbitration and become the STBM. Therefore, the SPA goes in P2 of the lowest-numbered slot that holds a TI System V processor.

---

**NOTE:** Do not attempt to install the SPA in any slot that contains an Explorer, Explorer II™ Explorer II Plus™, or other Explorer-family symbolic processor. The SPA works only with numeric processors that execute TI System V in a System 1500 or Explorer LX computing system.

---

Each SPA has an ID number located on the SPA board protective cover (NO TAG). Record the SPA ID number from the SPA label. You will need the SPA ID number and the sales order number if you ever have to purchase a replacement SPA from Texas Instruments. The same SPA is used on 68020, 68030, and 68040MP processors. Additional information on the SPA and SPA password appears in the *System Operation* manual.

To install the SPA, perform the following steps:

1. Remove the SPA from its antistatic shipping bag and place it on an antistatic surface.
2. Remove power from the system enclosure as described in the part of *Computer Enclosure Installation and Operation* that applies to your system enclosure.

---

**WARNING:** To eliminate the possibility of electrical shock during option or upgrade installation, you must isolate the system enclosure from all potential energy sources. To isolate the system enclosure:

1. Power off the system enclosure and all peripherals.
  2. Disconnect the power cable from the wall outlet of all local peripherals connected to the system enclosure.
  3. Disconnect all interface cables between the system enclosure and all remote peripherals.
  4. Unplug the system enclosure power cable from the wall outlet.
- 

3. Refer to the *Computer Enclosure Installation and Operation* manual for instructions on gaining access to the rear of the backplane. Locate P2 of the slot containing the processor board. In a multiprocessor system, select the lowest-numbered slot that contains a processor board.

Explorer II and Explorer II Plus are trademarks of Texas Instruments Incorporated.

4. Position the SPA so that the shield faces to the left, the 96-pin connector faces toward the backplane, and the two 18-pin cable ports are at the top of the SPA, facing out from the backplane.
5. Slide the SPA into the mounting rails until it is seated in the backplane P2 connector.
6. Install the SMT cable in the SPA port, following the instructions in the next paragraph.

Figure 3-4

---

**SPA Identification Label**

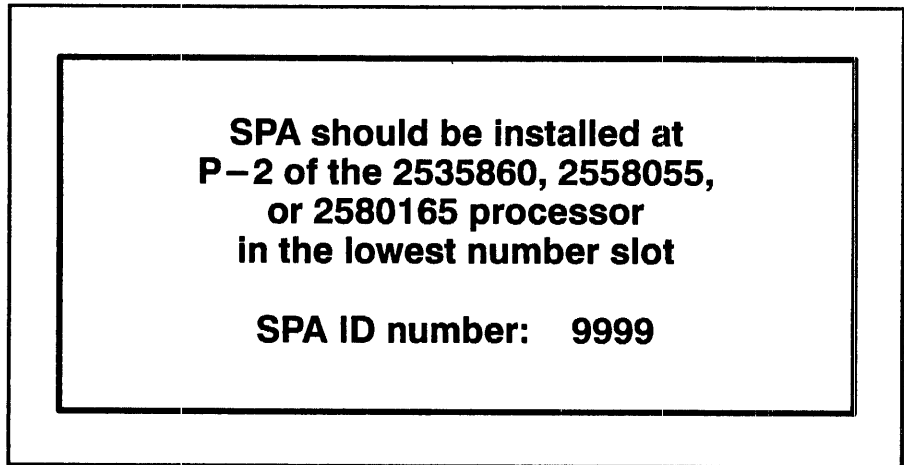

**Installing the SMT Cable**

**3.4.4** The following procedure describes direct cabling from the SPA to a local video display terminal (VDT) or to a modem for communication with a remote SMT. If your system includes the diagnostic panel with local/remote switching, refer to the 16-slot computer enclosure description in *Computer Enclosure Installation and Operation* for diagnostic panel cabling information.

The SMT cable provides an interface between the SPA and the SMT. Figure 3-5 shows the relationship between the processor, the SPA, and the SMT cable. The lower cable connector on the SPA supports a baud rate of 1200 and is used when connecting the SPA to a modem for remote location support and system boot operation. The upper cable connector on the SPA supports a baud rate of 9600 and is used to connect a local VDT. To install the SMT cable, proceed as follows:

1. Verify that power is off the system enclosure and peripherals and that the ac power cord is removed from the system enclosure.
2. Gain access to the the rear of the backplane as described in *Computer Enclosure Installation and Operation*.
3. Route the 18-pin connector of the SMT cable to the SPA.

4. Attach the 18-pin cable connector to the port corresponding to the speed of the device you are installing, as follows:
  - Upper port — 9600 bits per second (local console)
  - Lower port — 1200 bits per second (modem)

---

**NOTE:** The system supports only one SMT. Do not connect more than one cable to the SPA at a time unless the system enclosure includes the diagnostic panel with SMT remote/local switching, as described in *Computer Enclosure Installation and Operation*.

---

5. Attach the other end of the cable to the appropriate VDT or modem.
6. Close the system enclosure and return the system to operation. Refer to *Terminal/Printer Information* and to the manual for your particular terminal for SMT setup data. Additional information on the system boot process appears in *System Operation* and in the TI System V documentation.

**Figure 3-5 68040MP Processor, Memory Expansion, SPA, and Cabling**

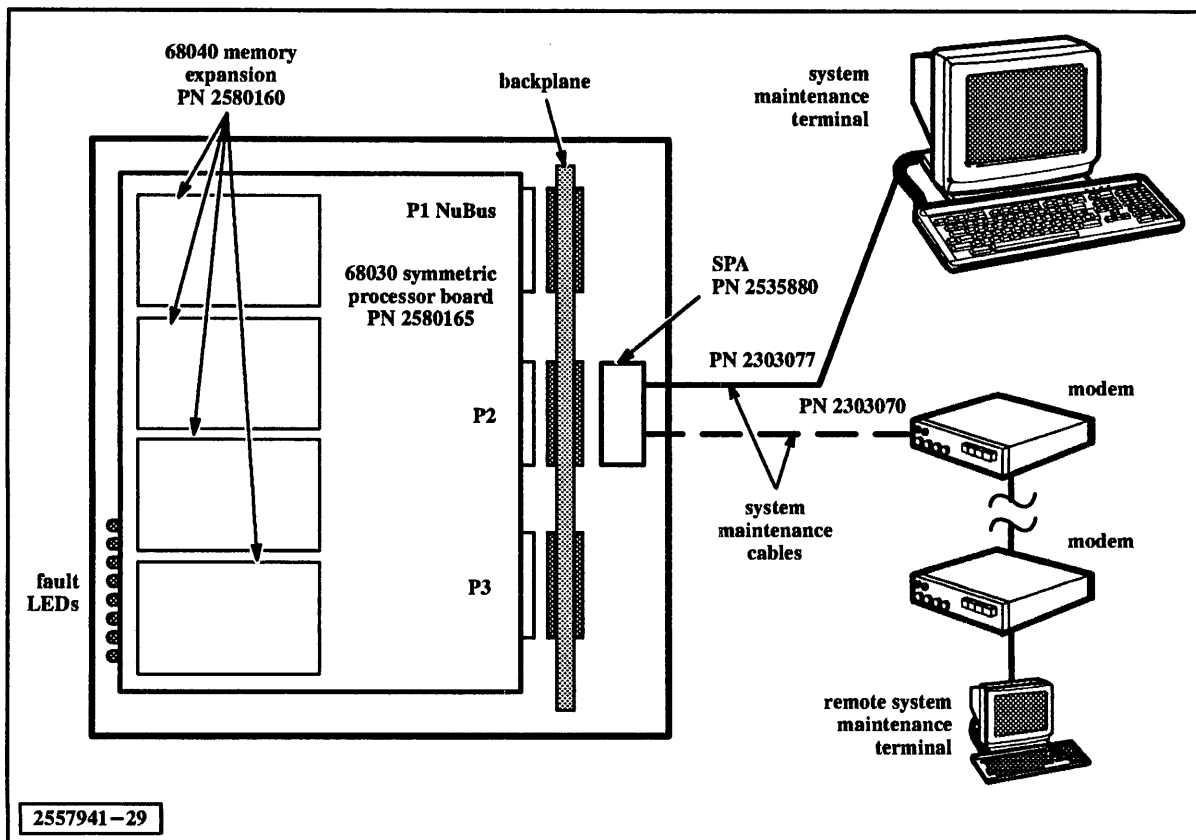

### Installing the LAN/SCSI Adapter

3.4.5 The LAN/SCSI cable adapter assembly Figure 3-6 provides for either AUI or BNC Ethernet connection, as well as a connection for the SCSI cable. It is installed on the backplane at connector P3 of the slot in which the 68040MP processor assembly is installed. When neither the LAN nor the SCSI options are being used, the LAN/SCSI adapter need not be installed.

Figure 3-6

### LAN/SCSI Adapter

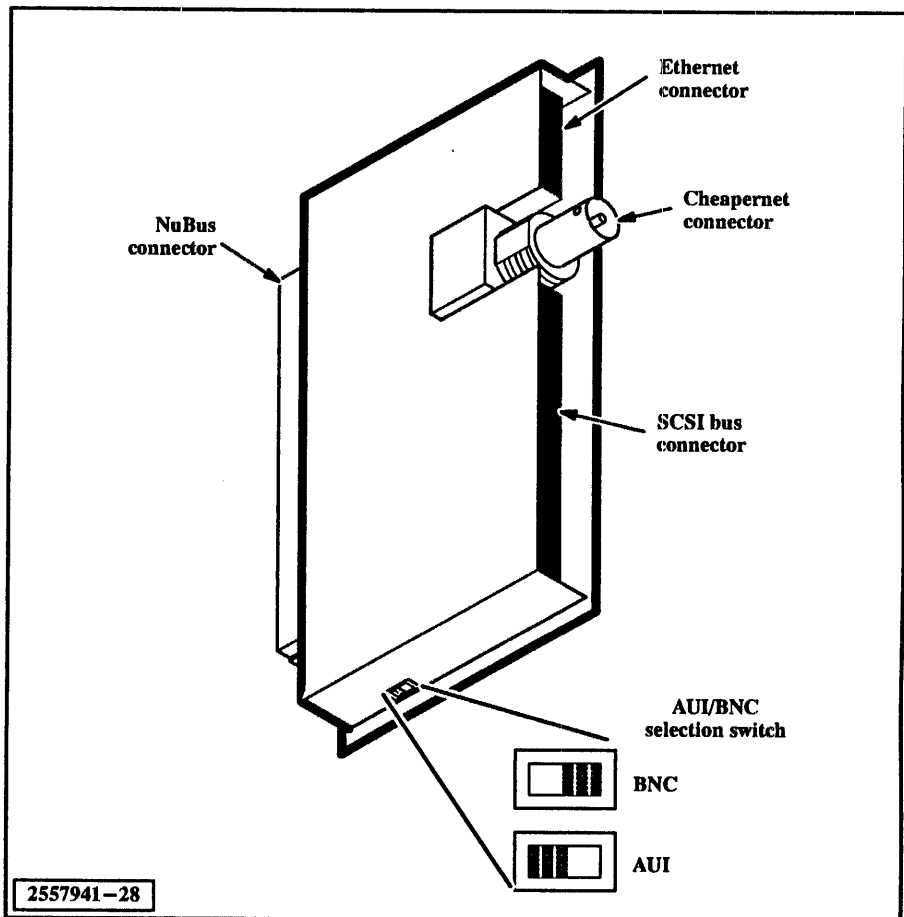

**NOTE:** Do not attempt to install the LAN/SCSI adapter in any slot that contains a 68020 processor, a 68030 processor, or an Explorer, Explorer II, Explorer II Plus, or other Explorer-family symbolic processor. The LAN/SCSI adapter works only with the 68040MP processor assembly.



To install the LAN/SCSI adapter, perform the following steps:

1. Remove the LAN/SCSI adapter from its antistatic shipping bag and place it on an antistatic surface.
2. If the LAN option is to be used, set the switch (Figure 3-6) to the appropriate Ethernet configuration.
3. Remove power from the system enclosure as described in the part of *Computer Enclosure Installation and Operation* that applies to your system enclosure.

---

**WARNING:** To eliminate the possibility of electrical shock during option or upgrade installation, you must isolate the system enclosure from all potential energy sources. To isolate the system enclosure:

1. Power off the system enclosure and all peripherals.
  2. Disconnect the power cable from the wall outlet of all local peripherals connected to the system enclosure.
  3. Disconnect all interface cables between the system enclosure and all remote peripherals.
  4. Unplug the system enclosure power cable from the wall outlet.
- 

4. Refer to the *Computer Enclosure Installation and Operation* manual for instructions on gaining access to the rear of the backplane. Locate P3 of the slot containing the 68040MP processor board.
5. Position the LAN/SCSI adapter so that the shield faces to the left, the 96-pin connector faces toward the backplane, and the Ethernet cable ports are at the top of the LAN/SCSI adapter, facing out from the backplane.
6. Slide the LAN/SCSI adapter into the mounting rails until it is seated in the backplane P3 connector.
7. Install the SCSI cable, if it is to be used, in the 50-pin SCSI port, following the instructions in (put section name here).
8. If using the AUI LAN connection, refer to (put section name here) for cable installation instructions. If using the BNC LAN connection, refer to (put section name here) before installing the cable.

### Connecting an External SCSI Device

3.4.6 The following procedure describes the cabling from the LAN/SCSI adapter to one or more external SCSI devices. (See Figure 3-7.) The SCSI cable provides a connection between the internal SCSI bus and external SCSI devices. The lower cable connector on the LAN/SCSI is the SCSI connector.

Figure 3-7 Connecting an External SCSI Device

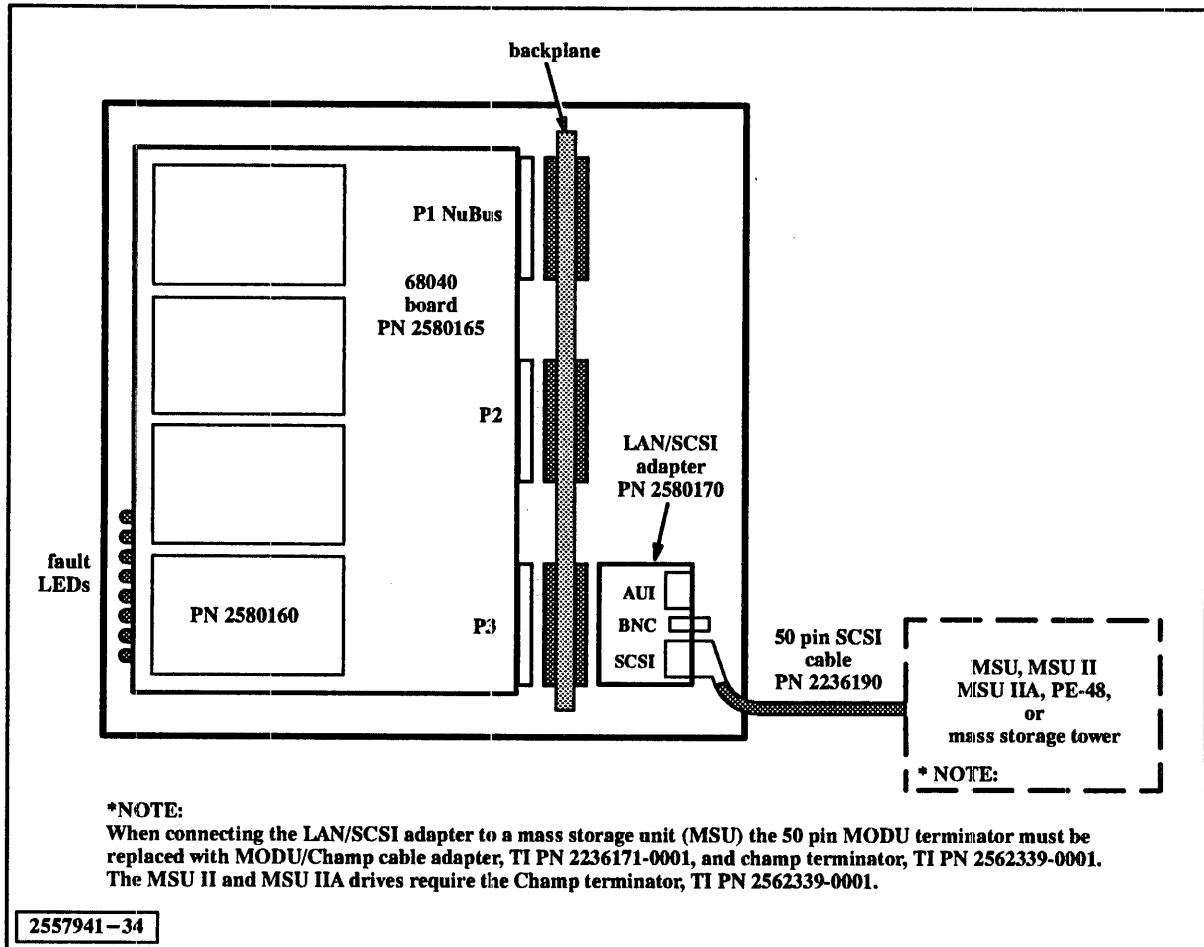

To install the SCSI cable, proceed as follows:

1. Verify that power is off the system enclosure and peripherals and that the ac power cord is removed from the system enclosure.
2. Gain access to the the rear of the backplane as described in *Computer Enclosure Installation and Operation*.
3. Route the connector of the SCSI cable to the LAN/SCSI adapter.
4. Attach the SCSI cable connector to the bottom connector on the LAN/SCSI adapter.

5. Attach the other end of the cable to the appropriate SCSI device.

---

**IMPORTANT:** Only use the SCSI terminator TI P/N 2236171-0001 with the 68040MP. Earlier SCSI terminators can cause system failures. When connecting the LAN/SCSI adapter to a Mass Storage Unit (MSU), the 50-pin AMP MODU terminator must be replaced with a MODU/CHAMP cable adapter, TI P/N 2236171-0001, and a CHAMP terminator, TI P/N 2562339-0001 (Figure 3-8). MSU II or MSU IIa enclosures must also have the newer CHAMP terminator, TI P/N 2562339-0001, installed in place of the older CHAMP terminator, TI P/N 2236188-0001.

---

6. Close the system enclosure and return the system to operation. Refer to *Mass Storage Unit (MSU IIa) Installation and Operation*, *Peripheral Enclosure Installation and Operation*, or *Mass Storage Tower Installation and Operation*, depending on your configuration, for additional SCSI device setup information.

Figure 3-8

## SCSI Champ Terminator and MSU Cable Adapter

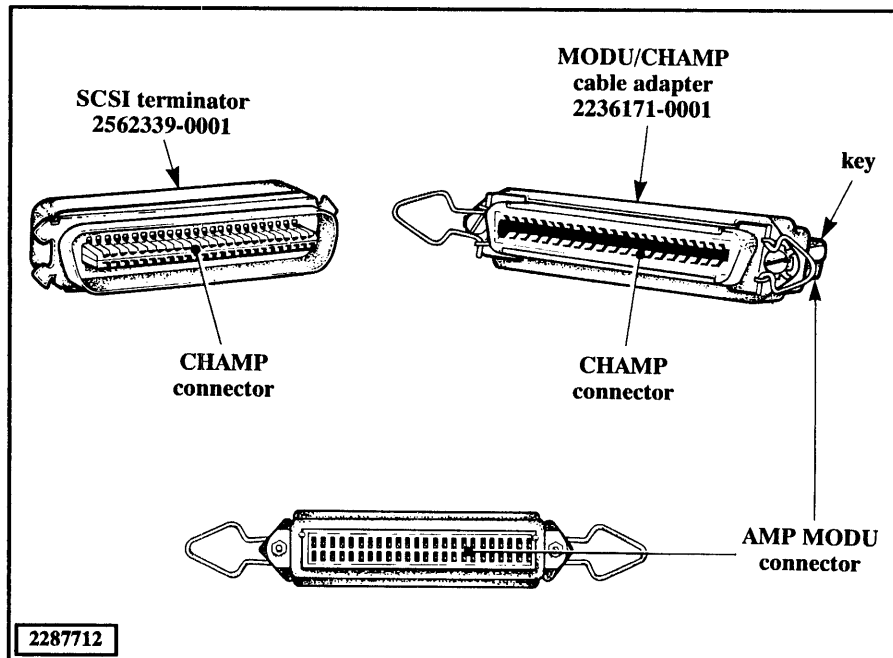

**Connecting an Ethernet LAN to the AUI Connector**

---

**3.4.7** The following procedure describes cabling from the AUI connector on the LAN/SCSI adapter to an existing LAN (Figure 3-9). An additional Ethernet cable assembly and Ethernet transceiver, are required.

The Ethernet cable, TI P/N 2239129-0001, provides a connection between the 18-pin, male, MODU-type connector on the LAN/SCSI adapter to the male, 15-pin, D-type connector on the Ethernet transceiver, TI P/N 2244733-0001. To install the Ethernet cable assembly and transceiver on an existing Ethernet LAN, proceed as follows:

1. Verify that power is off the system enclosure and peripherals and that the ac power cord is removed from the system enclosure.
2. Gain access to the the rear of the backplane as described in *Computer Enclosure Installation and Operation*.
3. Route the 18-pin, female, MODU-type connector of the Ethernet cable assembly, TI part number 2239129-0001, to the LAN/SCSI adapter.
4. Attach the 18-pin cable connector to the male, MODU-type connector at the top of the LAN/SCSI adapter.
5. Close the system enclosure.
6. Attach the 15-pin, female, D-type connector end of the Ethernet cable assembly to the new transceiver, TI P/N 2244733-0001. To attach the cable, slide the latch on the cable connector to the open position (Figure 3-9), place the cable connector over the male connector on the transceiver, and then slide the latch to its locked position. The slide latch should engage the two studs on the transceiver connector.
7. Connect the existing Ethernet backbone cables to both screw connectors of the new transceiver.
8. Return the system to operation.

Figure 3-9 Connecting the AUI Connector to the end of an Existing Ethernet LAN

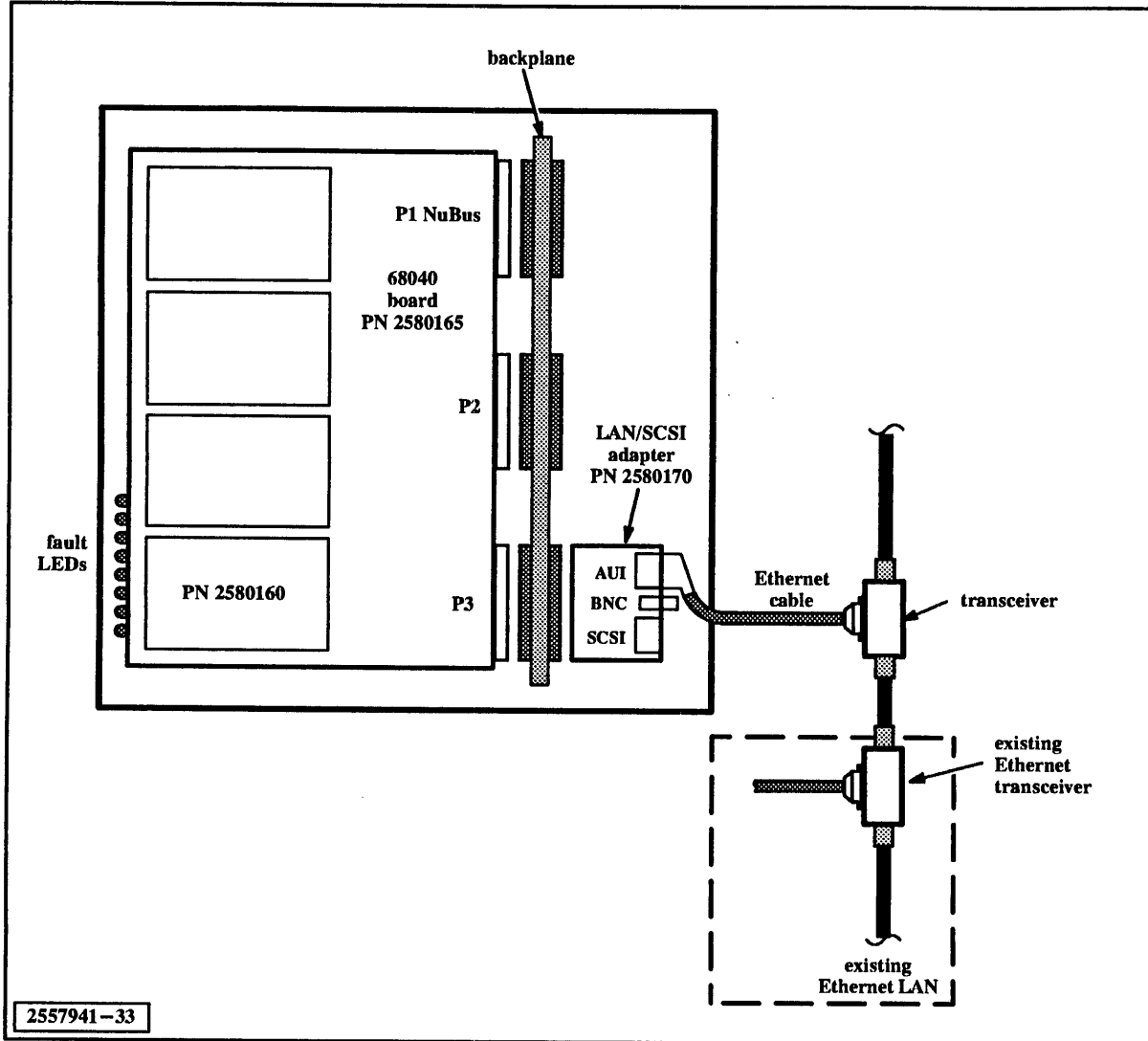

**Connecting an  
Ethernet LAN to the  
BNC Connector**

---

**3.4.8** The following procedure describes connecting the BNC (Cheapernet) connector on the LAN/SCSI adapter to an existing Ethernet transceiver (Figure 3-10).

The BNC T connector, TI P/N 0411063-0001, attaches to the LAN/SCSI adapter. A thin Ethernet cable assembly then connects the BNC T connector to the existing Ethernet transceiver, TI P/N 2244733-0001. To connect to an existing Ethernet LAN via the BNC connector of the LAN/SCSI adapter, proceed as follows:

1. Verify that power is off the system enclosure and peripherals and that the ac power cord is removed from the system enclosure.
2. Remove the terminator from the existing Ethernet transceiver.
3. Attach the thin Ethernet cable assembly, TI P/N 2239703-000n, to the transceiver.
4. Gain access to the the rear of the backplane as described in *Computer Enclosure Installation and Operation*.
5. Route the thin Ethernet cable assembly, TI part number 2239703-000n, to the LAN/SCSI adapter.
6. Attach the thin Ethernet cable to the BNC T connector installed in step 5.
7. Install the terminator removed in step 2 on the BNC T connector attached to the LAN/SCSI board. Connect the ground lug of the terminator to earth ground. Position the BNC T connector so that it does not interfere with the other cabling within the cabinet.
8. Return the system to operation.

**Figure 3-10** Connecting the AUI Connector to the end of an Existing Thin Ethernet LAN

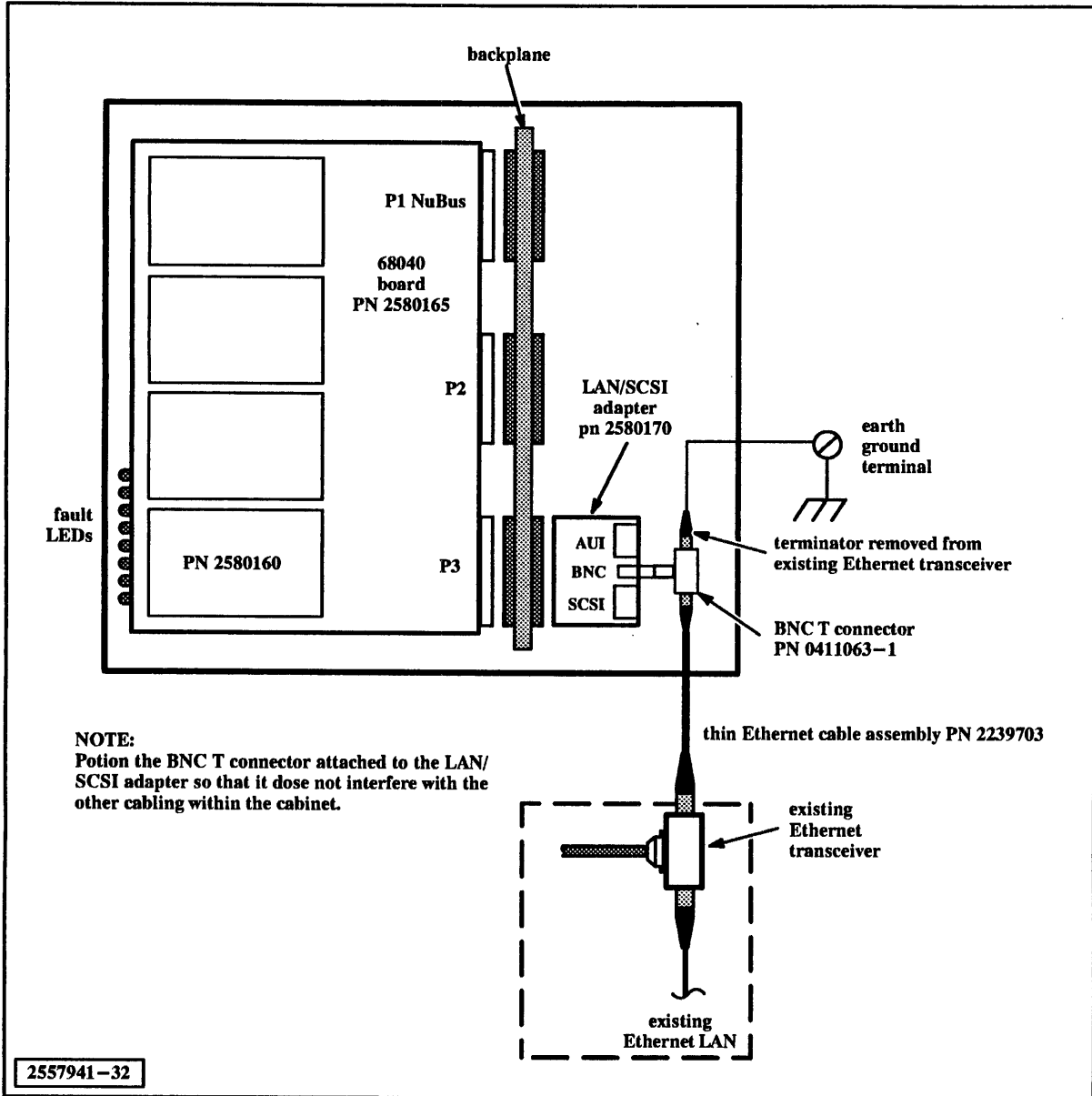

**LED Indicator Operation**

3.5 Eight LED indicators are located on the board edge, as shown in Figure 3-11. These indicators are:

- Green (top) — SCSI terminator fuse okay
- Yellow — SCSI bus fault
- Red — SCSI fault
- Red — LAN fault
- Green — Programmable interval timer (PIT) OK
- Red — Uncorrectable memory error
- Yellow — LAN or SCSI sub-fault
- Red (bottom) — Self-test/board fault

**Figure 3-11 Processor Board LED Indicators**

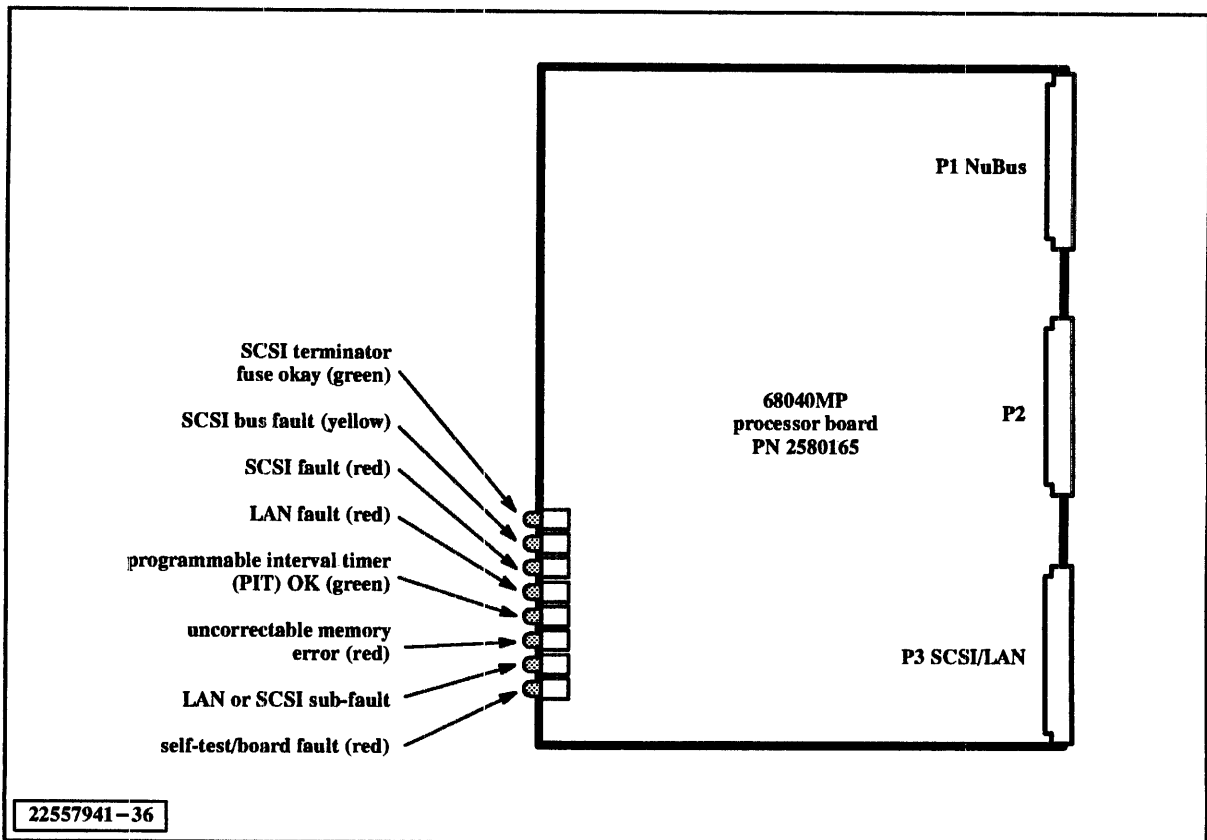



The green SCSI terminator power fuse LED indicates that the 68040MP processor assembly is providing termination power, via a fuse on the board, to the mass storage devices on the SCSI bus.

The yellow SCSI bus fault LED indicates that the SCSI bus or a mass storage device on the SCSI bus has failed.

The red SCSI fault LED remains lit when the SCSI subsystem on the 68040MP processor assembly has failed. The other functions of the 68040MP processor assembly may remain operational after the failure of the SCSI subsystem.

The red LAN fault LED indicates that the LAN subsystem on the 68040MP processor assembly has failed if it comes on at any time other than briefly during self-test. The other functions of the 68040MP processor assembly may remain operational after the failure of the LAN subsystem.

The green PIT OK indicator remains on while the processor services normal PIT interrupts. The PIT overrun indicator may turn off momentarily as part of the power-up self-test and system boot process.

The red memory error LED lights when any read error occurs in expansion memory. Single bit errors are corrected automatically. The processor cannot correct 2-bit errors automatically. If the 2-bit error is the result of a memory read by a remote NuBus master, the processor informs the NuBus master via a status code at the end of the bus transfer. The error signal latches on the first uncorrectable error, and does not clear until a reset occurs or a software command clears the latch. If the indicator comes on at any time (except temporarily during self-test), service personnel should run memory diagnostic tests to confirm the problem and detect the failing device(s).

The yellow LAN or SCSI sub-fault LED is illuminated when a fault is detected with the LAN or SCSI sub-system or interface. An error condition does not exist with the main 68040 processor, which may continue to be used.

The red self-test/board fault LED lights at power-up and remains on until the self-tests complete successfully. The LED is controllable via a remote STBM processor or by the on-board 68040 processor. If the LED remains on after the self-tests have completed, service personnel should be contacted for repair.

# INDEX

---

## B

### boards

configuration restrictions: *68040MP* 3-1  
features: *68040MP* 1-4-1-5  
general description: *68040MP* 1-1-1-2  
installation: *68040MP* 3-5-3-6  
reference documents: *68040MP* 1-6  
shipping container: *68040MP* 2-2  
specifications: *68040MP* 1-5-1-6  
TI installation: *68040MP* 3-2  
unpacking: *68040MP* 2-1-2-3

## C

cautions, static electricity: *68040MP* 2-1, 3-2

## E

electrical shock warning: *68040MP* 3-6, 3-7, 3-11

## F

features: *68040MP* 1-4-1-5

## I

indicators, LED: *68040MP* 3-18-3-19

### installation

cautions: *68040MP* 3-2  
memory expansion board: *68040MP* 3-3-3-5  
processor board: *68040MP* 3-5-3-6  
software protection adapter (SPA): *68040MP*  
3-6-3-8  
system maintenance terminal cable: *68040MP*  
3-8-3-17  
warnings: *68040MP* 3-6, 3-7, 3-11

## L

LED indicators: *68040MP* 3-18-3-19

## M

### memory expansion board

general description: *68040MP* 1-3  
installation: *68040MP* 3-3-3-5  
TI installation: *68040MP* 3-2

## P

### processor board

configuration restrictions: *68040MP* 3-1  
features: *68040MP* 1-4-1-5  
figure: *68040MP* 1-2  
general description: *68040MP* 1-1-1-2  
installation: *68040MP* 3-5-3-6  
LAN/SCSI adapter: *68040MP* 1-4  
reference documents: *68040MP* 1-6  
software protection adapter (SPA): *68040MP*  
1-3, 3-10  
specifications: *68040MP* 1-5-1-6

## R

reference documents: *68040MP* 1-6  
restrictions, configuration: *68040MP* 3-1

## S

### shipping container

SPA: *68040MP* 2-3  
system board: *68040MP* 2-2  
software protection adapter (SPA)  
installation: *68040MP* 3-6-3-8  
shipping container: *68040MP* 2-3  
TI installation: *68040MP* 3-2  
specifications: *68040MP* 1-5-1-6  
static electricity caution: *68040MP* 2-1, 3-2  
system boards. *See* boards  
system maintenance terminal (SMT), cable  
installation: *68040MP* 3-8-3-17

## T

### TI-installation

memory expansion board: *68040MP* 3-2  
software protection adapter (SPA): *68040MP*  
3-2  
system boards: *68040MP* 3-2

## U

### unpacking

cautions: *68040MP* 2-1  
system boards: *68040MP* 2-1-2-3

## W

warnings, electrical shock: *68040MP* 3-6, 3-7, 3-11

**16/32-MEGABYTE  
DATA BUFFER BOARD**

---

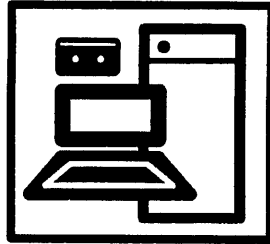



# CONTENTS

---

Paragraph	Title	Page
<b>1</b>	<b>16/32-Megabyte Data Buffer Board</b>	
1.1	Introduction .....	1-1
1.2	Features .....	1-2
1.3	Specifications .....	1-3
1.4	Reference Documents .....	1-4
<b>2</b>	<b>Data Buffer Board Unpacking</b>	
2.1	Unpacking .....	2-1
<b>3</b>	<b>Data Buffer Board Installation and Operation</b>	
3.1	Introduction .....	3-1
3.2	Configuration Restrictions .....	3-1
3.2	Arranging for TI Installation .....	3-2
3.4	Installing the Data Buffer Board .....	3-2
3.5	Data Buffer Board Operation .....	3-3
3.5.1	LED Indicator Operation .....	3-3
3.5.2	System Software Setup .....	3-3

---

## Index

---

Figure	Title	Page
<b>Figures</b>		
1-1	16/32-Megabyte Data Buffer Board .....	1-1
2-1	16/32-Megabyte Data Buffer Board Shipping Container .....	2-2
3-1	Data Buffer Board and Backplane .....	3-4

---

---

Table	Title	Page
<b>Table</b>		
1-1	16/32-Megabyte Data Buffer Board Specifications .....	1-3

---



# 16/32-MEGABYTE DATA BUFFER BOARD

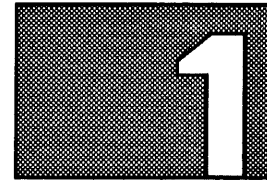

## Introduction

1.1 This section provides an introduction to the 16/32-megabyte data buffer board (Figure 1-1). This information is organized into three main topics:

- Features
- Specifications
- Reference documents

The 16/32-megabyte data buffer board is a standard triple-height Eurocard board that provides random-access memory for computing systems based on the 32-bit NuBus™ high-speed data bus. The data buffer board acts as a NuBus slave only, responding to access requests from processor boards, mass storage controllers, and other NuBus master devices.

Figure 1-1 16/32-Megabyte Data Buffer Board

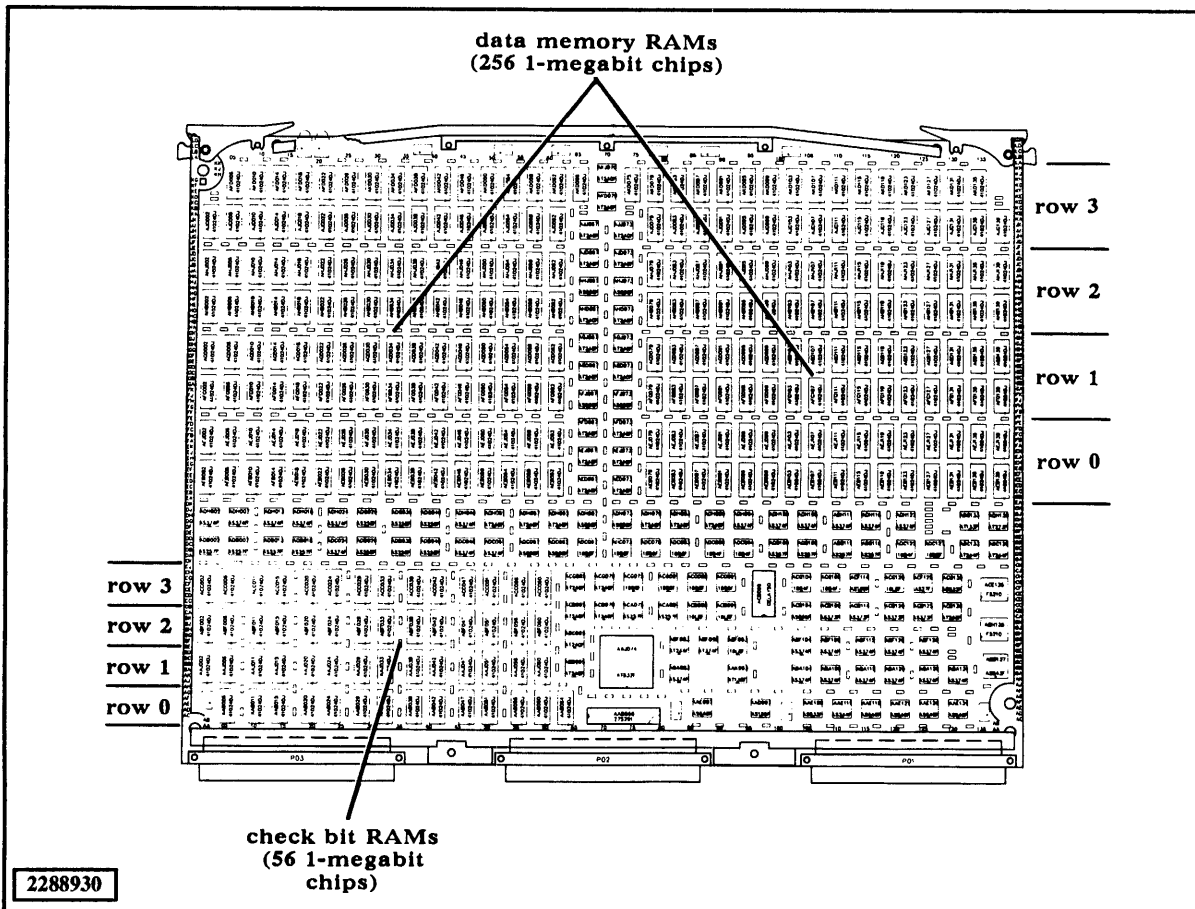

NuBus is a trademark of Texas Instruments Incorporated.

The 16/32-megabyte data buffer board was first introduced as a primary/secondary processor memory for use with the Explorer II™ symbolic processor, which has no onboard main memory. The data buffer board may be used with numeric processors and the TI System V operating system to serve as a disk cache memory for file system input/output (I/O) buffers and/or as a RAM disk. The 68040MP processor, the 68030 symmetric processor and the 68020 processor all have fast main memories and do not use the data buffer board for processor memory.

The data buffer board can be populated with memory chips for 8-, 16-, or 32-megabyte operation. There are no memory size jumpers on the data buffer board. The different capacity boards have the following part numbers:

Part Number	Memory Capacity
2540835-0001	32 megabytes
2540835-0003	16 megabytes
2540835-0004	8 megabytes

The data buffer board is organized into four horizontal rows of 64 memory data chips. Each row consists of two memory banks (bank A and B) with 32 memory data chips in each bank. Also, four corresponding rows of 14 check-bit data chips provide storage for seven check bits for each 32-bit memory data word.

---

## Features

1.2 The 16/32-megabyte data buffer board has the following key features:

- The data buffer board is available in different memory capacities to match system needs—8 megabytes, 16 megabytes, or 32 megabytes, using groups of 1-megabit dynamic random-access memory (DRAM) chips.
- The data buffer board uses parallel error detection and correction (EDAC) logic that detects and corrects single-bit errors transparently.
- A base register permits the on-board memory addresses to be moved anywhere in NuBus global address space.
- NuBus interface logic supports the following types of NuBus data transfers:
  - Slave read and write cycles in 8-bit bytes, 16-bit NuBus halfwords, or 32-bit NuBus words.
  - Slave read and write block transfers in increments of 2, 4, 8, or 16 words.
- The data buffer board conforms to the Texas Instruments NuBus system architecture and includes the configuration read-only memory (ROM), configuration register, and flag register required to support TI diagnostic testing and system boot software.
- Two fault light-emitting diode (LED) indicators on the board edge identify error conditions. The red LED indicates a board fault or an uncorrectable memory error. The yellow LED indicates a correctable memory error.

Explorer II is a trademark of Texas Instruments Incorporated.



**Specifications**

**1.3** Table 1-1 lists the hardware specifications of the 16/32-megabyte data buffer board.

**Table 1-1****16/32-Megabyte Data Buffer Board Specifications**

<b>Item</b>	<b>Specifications</b>
Form factor	Triple-height Eurocard
Capacity	8, 16, or 32 megabytes of DRAM organized 39 bits wide (32-bit words plus 7 check bits)
Error checking	Parallel error checking and correction logic detects and corrects all single-bit errors, detects all 2-bit errors
Access	NuBus slave read or write in single bytes, halfwords, words, or slave block transfer of 2, 4, 8, or 16 words
Addressing	8 megabytes accessible on power up, starting at the NuBus slot address, Fs000000. Loadable base register biases the memory into NuBus global address space
Clock input	10-megahertz NuBus clock with duty cycle of 75 nanoseconds unasserted (high) and 25 nanoseconds asserted (low)
Read access time*	
Single-word	5 NuBus clock periods
Block transfer	5 NuBus clock periods for the first word, 1 clock period for each additional word
Write access time*	
Single-word	3 NuBus clock periods
Block transfer	3 NuBus clock periods for the first word, 1 clock period for each additional word
Power	
Idle board	+5 volts, 11.8 amperes, 59 watts
Active board	+5 volts, 17.0 amperes, 85 watts
Temperature	
Operating	10° to 35° C (50° to 95° F)
Nonoperating	-40° to 65° C (-40° to 149° F)
Wet bulb	27° C (80° F) maximum
Relative Humidity	
Operating	20% to 80% (noncondensing)
Nonoperating	5% to 95% (noncondensing)

**Note:**

\* Read and write access times exclude NuBus arbitration time for the requesting NuBus master.

---

**Reference Documents**

**1.4** For additional technical information on the 16/32-megabyte data buffer board and its application in different computing systems, refer to the following documents:

- *IEEE Standard for a Simple 32-Bit Backplane Bus: NuBus*, IEEE Standard 1196-1987, (Institute of Electrical and Electronics Engineers, Inc.)
- *NuBus System Architecture General Description*, TI part number 2537171-0001
- *Explorer 32-Megabyte Memory Board General Description*, TI part number 2537185-0001
- *TI System V Administrator's Guide*, TI part number 2540539-0001
- *Explorer System Field Maintenance*, TI part number 2243141-0001
- *Explorer System Field Maintenance Supplement*, TI part number 2537183-0001
- *16/32-Megabyte Data Buffer Board Field Maintenance Supplement*, TI part number 2558003-0001
- *NuBus Systems System 1500 Field Maintenance*, TI part number 2549258-0001

---

**NOTE:** Various documents describe the 16/32-megabyte data buffer board under the following names: 32-megabyte memory board, Explorer II memory board and Explorer™ 32-megabyte memory board.

---

Explorer is a trademark of Texas Instruments Incorporated.

## DATA BUFFER BOARD UNPACKING

---

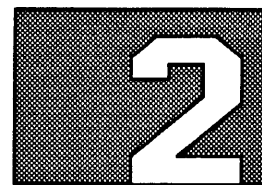

### Unpacking

**2.1** System owners who install their own circuit boards should perform the following steps to unpack the equipment:

1. Visually inspect the shipping container for damage. If the inspection reveals damage to the shipping container, contact the carrier agent for instructions on filing a claim. The carrier, not Texas Instruments, is responsible for damage during shipment. Resolve all problems relating to shipping damage before proceeding with the installation.
2. Note on the delivery receipt any problems that you discover.
3. Be sure that the driver has signed the delivery receipt.
4. Obtain a knife for cutting the sealing tape that secures the packing container.

---

**CAUTION:** The data buffer board contains static-sensitive electronic components. To avoid damage to these components, ensure that you are well grounded before handling the system board.

The recommended method is to use a static-control system consisting of a static-control floor or table mat and a static-control wrist strap. These are commercially available. If you do not have a static-control system, you can discharge any accumulated static charge by touching a grounded object prior to handling the system board.

Before storing or transporting the memory board, return it to its protective package.

---

5. As you unpack the data buffer board (Figure 2-1), inspect the equipment for shipping damage. If the inspection reveals damage that you feel is significant, stop the unpacking procedure and contact the carrier agent. After the carrier agent inspects the damage, contact a Texas Instruments Field Service office. Save all the packing material for future use whenever possible.
6. Leave the data buffer board in its antistatic bag until you install it in the computer system enclosure.

Figure 2-1

16/32-Megabyte Data Buffer Board Shipping Container

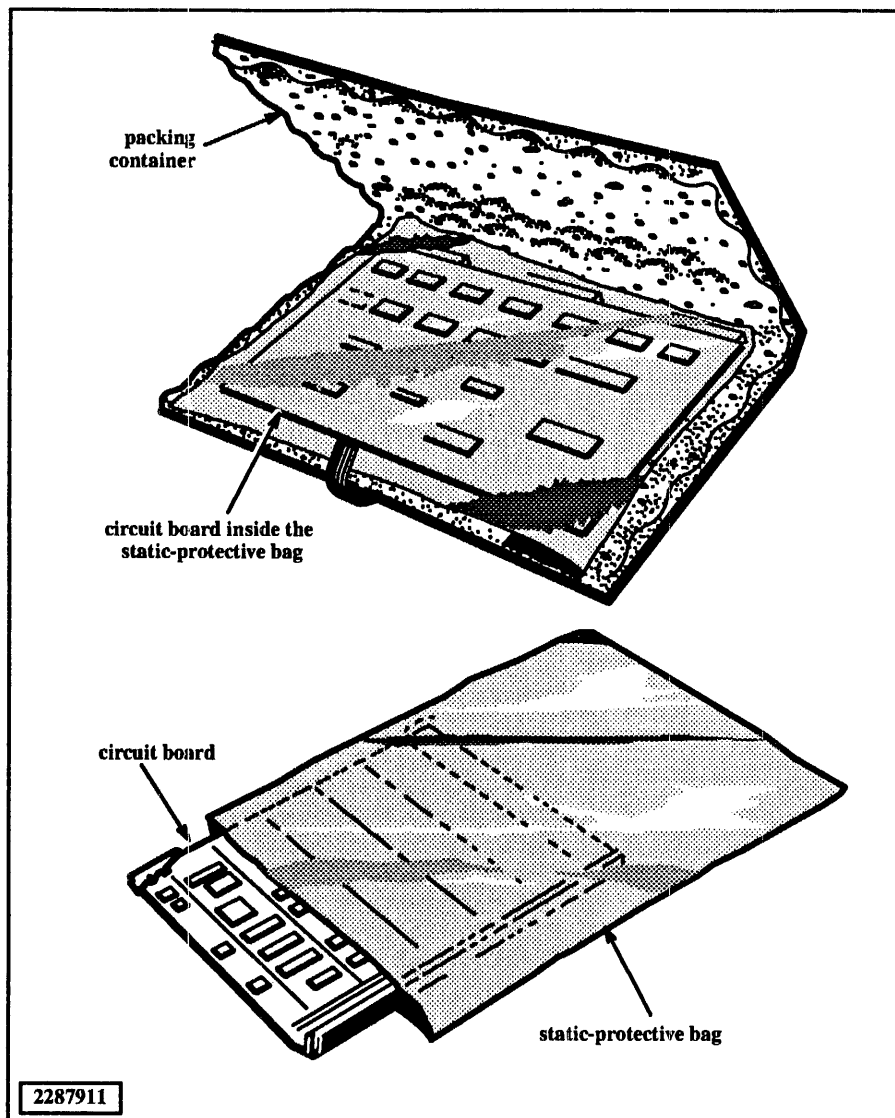

# DATA BUFFER BOARD INSTALLATION AND OPERATION

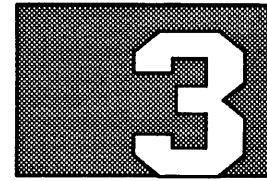

---

## Introduction

**3.1** This section provides information on installation and operation of the 16/32-megabyte data buffer board. The installation instructions apply to situations where you are adding a memory board to an existing computer system. If you have purchased a new computer system that includes the data buffer board, the board is installed at the factory.

If you purchased the data buffer board to upgrade an existing system, you have the option of installing the board yourself or having Texas Instruments perform the installation for you.

---

**CAUTION:** All boards, options, adapters, and peripherals contain components that are sensitive to static electricity. When handling any of these items, protect against static electricity by using wrist grounding straps, grounded working mats, and antistatic bags for moving or storing the items.

---

---

## Configuration Restrictions

**3.2** There are hardware and software restrictions on the number of data buffer boards within a computer system enclosure. These restrictions may change with hardware changes and software releases. Unless you are replacing an existing 16/32-megabyte data buffer board, you should know about these restrictions. Present restrictions include:

- TI System V, release 2.3 operating system software supports up to 4 fully-populated 32-megabyte data buffer boards for use as a software-managed RAM disk and/or as file system I/O buffer memory. This capability is not present in earlier releases.
- TI System V operating system software does not support use of the 16/32-megabyte data buffer board as processor local memory. The NuBus overhead time makes the 32-megabyte memory inefficient for such use.
- Adding the data buffer board must not exceed the operating current capability of the computer enclosure power supply. Refer to the specifications in Section 1 for the data buffer board current requirements.

Contact your Texas Instruments representative for additional information.

---

### Arranging for TI Installation

3.3 The following procedure outlines the tasks you must perform before TI installs your data buffer board:

1. Note the system serial number from the original system documents or from the box that contained this manual.
2. Call the Field Service Communications Center (FSCC) at telephone number 1-800-572-3300 to schedule the installation. The following information is required to schedule a TI installation:
  - System serial number
  - Customer name
  - Customer street address, city, state, and zip code
  - Name and telephone number of customer personnel to contact
  - Purchase order number if the installation was not ordered with the equipment

---

### Installing the Data Buffer Board

3.4 To install the 16/32-megabyte data buffer board, observe all safety warnings and cautions while performing the following steps:

1. Remove the memory board from the system enclosure or its antistatic shipping bag, and place it on an antistatic surface.
2. Record the amount of memory actually on the data buffer board. This information is required to properly set up operating system parameters.
3. Remove power from the system enclosure as described in the part of *Computer Enclosure Installation and Operation* that applies to your system enclosure.

---

**WARNING:** To eliminate the possibility of electrical shock during option or upgrade installation, you must isolate the system enclosure from all potential energy sources. To isolate the system enclosure:

1. Power off the system enclosure and all peripherals.
  2. Disconnect the power cable from the wall outlet of all local peripherals connected to the system enclosure.
  3. Disconnect all interface cables between the system enclosure and all remote peripherals.
  4. Unplug the system enclosure power cable from the wall outlet.
- 

4. Gain access to the system enclosure card cage as described in *Computer Enclosure Installation and Operation*.

5. Install the data buffer board in a vacant slot, following the instructions for Eurocard circuit board installation provided in *Computer Enclosure Installation and Operation*.
6. Close up the system enclosure and return the system to operation. Perform the extended memory diagnostic tests to verify memory operation.
7. Refer to the information on external memory boards and RAM disk in the *TI System V Administrator's Guide* for information on partitioning the added memory between RAM disk and file system buffer cache. The operating system cannot make use of the added memory until the appropriate parameters are modified and the system rebooted.

---

## Data Buffer Board Operation

3.5 Data buffer board operation consists of interpreting the LED fault indicators and performing the initial software setup operations.

### LED Indicator Operation

3.5.1 The data buffer board has two LED indicators (Figure 3-1) that provide information about fault status of the board. These indicators are:

- Yellow — Correctable memory error
- Red — Board fault or uncorrectable memory error

The yellow correctable memory error LED lights when the data buffer board detects and corrects a single-bit memory read error. The indicator latches on the first error and does not clear until a reset occurs or a software command clears the latch. If this indicator comes on consistently, memory performance is deteriorating. Service personnel should run memory diagnostic tests to confirm the problem and detect the failing device.

The red error LED board fault or uncorrectable error LED may be driven by either of two sources. Diagnostic software may drive the LED through the on-board configuration register. In this case, the LED is serving as the self-test and board fault indicator. Diagnostic tests, executed by a processor board, set the LED on at power-up and turn it off upon successful completion of the memory diagnostic tests. If the tests fail, the LED stays on.

The other source that can drive the red LED is the uncorrectable memory error output of the EDAC circuitry. This error occurs when any 2-bit memory read error occurs. The data buffer board cannot correct the error automatically, but it does inform the NuBus master via a status code at the end of the bus transfer. The uncorrectable error signal latches on the first uncorrectable error and does not clear until a reset occurs or a software command clears the latch. If the indicator comes on at any time (except temporarily during self-test), service personnel should run memory diagnostic tests to confirm the problem and detect the failing device(s).

### System Software Setup

3.5.2 Explorer software automatically incorporates the 16/32-megabyte data buffer board as processor local memory. TI System V software, release 2.3 and later, allows the system administrator to partition the added memory between a RAM disk and file system I/O buffers.

A RAM disk is a block of random-access memory that emulates the operation of a hard disk. Once a RAM disk is loaded with files (from a hard disk), processors can access files from the RAM disk much faster than from a real hard disk. Unlike a hard disk, all data in a RAM disk is lost in the event of a reset or a power failure. Writes to a RAM disk do not automatically update the source files on the hard disk. TI System V requires an explicit command to write the RAM disk files to the hard disk. A RAM disk is ideal for read-only files or for executable files that are not modified during execution.

File system I/O buffers store fixed-size pages of data from the file system. These buffers are allocated in processor local memory and may also be allocated from the 16/32-megabyte data buffer board(s). These buffers act as a disk cache, and eliminate hard disk accesses to reach data that is present in the buffers.

Allocation of memory to RAM disk or to file system I/O buffers is a system administrator function. For information on allocating memory and on managing the RAM disk, refer to the information on external memory boards and RAM disk in your *TI System V Administrator's Guide*.

Figure 3-1

Data Buffer Board and Backplane

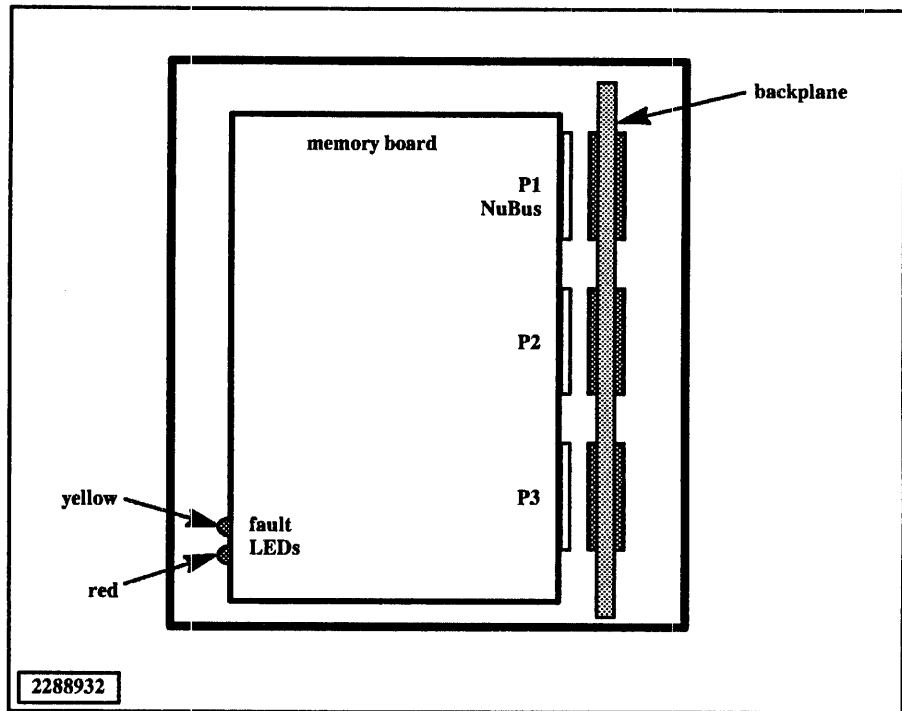



## Numbers

16/32-megabyte data buffer board  
configuration restrictions: *32MB 3-1*  
features: *32MB 1-2*  
general description: *32MB 1-1-1-2*  
installation: *32MB 3-2-3-3*  
operation: *32MB 3-3-3-4*  
reference documents: *32MB 1-4*  
shipping container: *32MB 2-2*  
specifications: *32MB 1-3*  
TI installation: *32MB 3-2*  
unpacking: *32MB 2-1-2-2*

## B

boards  
configuration restrictions: *32MB 3-1*  
features: *32MB 1-2*  
general description: *32MB 1-1-1-2*  
installation: *32MB 3-2-3-3*  
operation: *32MB 3-3-3-4*  
reference documents: *32MB 1-4*  
shipping container: *32MB 2-2*  
specifications: *32MB 1-3*  
TI installation: *32MB 3-2*  
unpacking: *32MB 2-1-2-2*

## C

cautions, static electricity: *32MB 2-1, 3-1*

## D

data buffer board. *See* boards, 16/32-megabyte data buffer board

## E

electrical shock warning: *32MB 3-2*

## F

features: *32MB 1-2*

## I

indicators, LED: *32MB 3-3*  
installation  
cautions: *32MB 3-1*  
data buffer board: *32MB 3-2-3-3*  
warnings: *32MB 3-2*

## L

LED indicators: *32MB 3-3*

## O

operation, data buffer board: *32MB 3-3-3-4*

## R

reference documents: *32MB 1-4*  
restrictions, configuration: *32MB 3-1*

## S

shipping container, data buffer board: *32MB 2-2*  
specifications: *32MB 1-3*  
static electricity caution: *32MB 2-1, 3-1*

## T

TI-installation, data buffer board: *32MB 3-2*

## U

unpacking  
cautions: *32MB 2-1*  
data buffer board: *32MB 2-1-2-2*

## W

warnings, electrical shock: *32MB 3-2*

**NUPI BOARD**

---

---

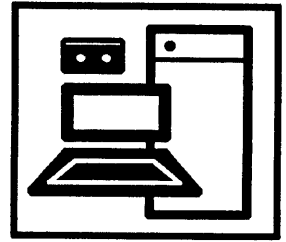



# CONTENTS

---

Paragraph	Title	Page
<b>1</b>	<b>NUPI Overview</b>	
1.1	NUPI Subsystem .....	1-1
1.2	NUPI Board .....	1-1
<b>2</b>	<b>NUPI Unpacking</b>	
2.1	Unpacking the System Board and Associated Cable Adapters .....	2-1
<b>3</b>	<b>NUPI Installation and Operation</b>	
3.1	System Board Installation .....	3-1
3.2	TI-Installed System Board and Associated Cable Adapters .....	3-1
3.3	Operation of NUPI Board LED Indicators .....	3-3

---

## Index

---

Figure	Title	Page
<b>Figures</b>		
1-1	NUPI Board .....	1-2
2-1	System Board Shipping Container .....	2-2
2-2	Typical Cable Adapter Shipping Container .....	2-3
3-1	NUPI Board Cabling .....	3-3

---



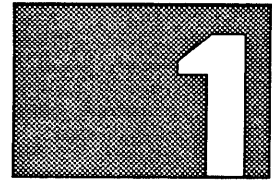

## NUPI OVERVIEW

---

### NUPI Subsystem

1.1 The NuBus™ peripheral interface (NUPI) board, shown in Figure 1-1, converts the the internal system enclosure NuBus format data to the small computer system interface (SCSI) format for use by the DB380 disk, CT60 cartridge tape, and MT3201 1/2-inch tape mass storage devices. The key features of the NUPI are:

- Data transfer rates of up to 1.5 megabytes per second between the NuBus and the SCSI bus
- Extensive onboard self-test diagnostic capability
- Support for up to four mass storage enclosures

The physical interface between the enclosure and the mass storage devices consists of a peripheral cable adapter (PCA) and a SCSI cable. The PCA connects to the backplane, connector P3, of each slot containing a NUPI board. (More than one NUPI can be installed in a system.) The SCSI cable connects from the PCA to the mass storage enclosure.

---

### NUPI Board

1.2 The NUPI board contains a microprocessor, read-only memory (ROM), random-access memory (RAM), interval timer, and associated logic.

All NUPI operations are under the control of the onboard 68000 microprocessor (MPU) and its associated logic. The MPU processes NuBus commands, issues SCSI commands, and executes NUPI and SCSI self-tests. The MPU initiates commands to the SCSI bus via the SCSI controller of the NUPI.

The NUPI onboard ROM stores information in the form of 16-bit halfwords in two 8192-by-8-bit ROM chips. These ROM chips contain the MPU firmware, the NUPI configuration data, the NUPI and SCSI self-test firmware, and the NUPI device service routine (DSR) boot code.

The NUPI onboard RAM stores information in the form of 16-bit halfwords in two 2048-by-8-bit RAM chips. These RAM chips contain the NUPI command address register, the NUPI configuration register, various control and status registers, and internal control data structures for all active commands.

The interval timer contains the NuBus data transfer count during direct memory access (DMA) operations. The MPU initializes the count prior to a DMA data transfer operation and decrements the count after each 32-bit NuBus word has been transferred. An expired count signals the end of the transfer operation. The interval timer also provides onboard event generation for polling and time-outs. Figure 1-1 shows a block diagram of the NUPI board.

NuBus is a trademark of Texas Instruments Incorporated.

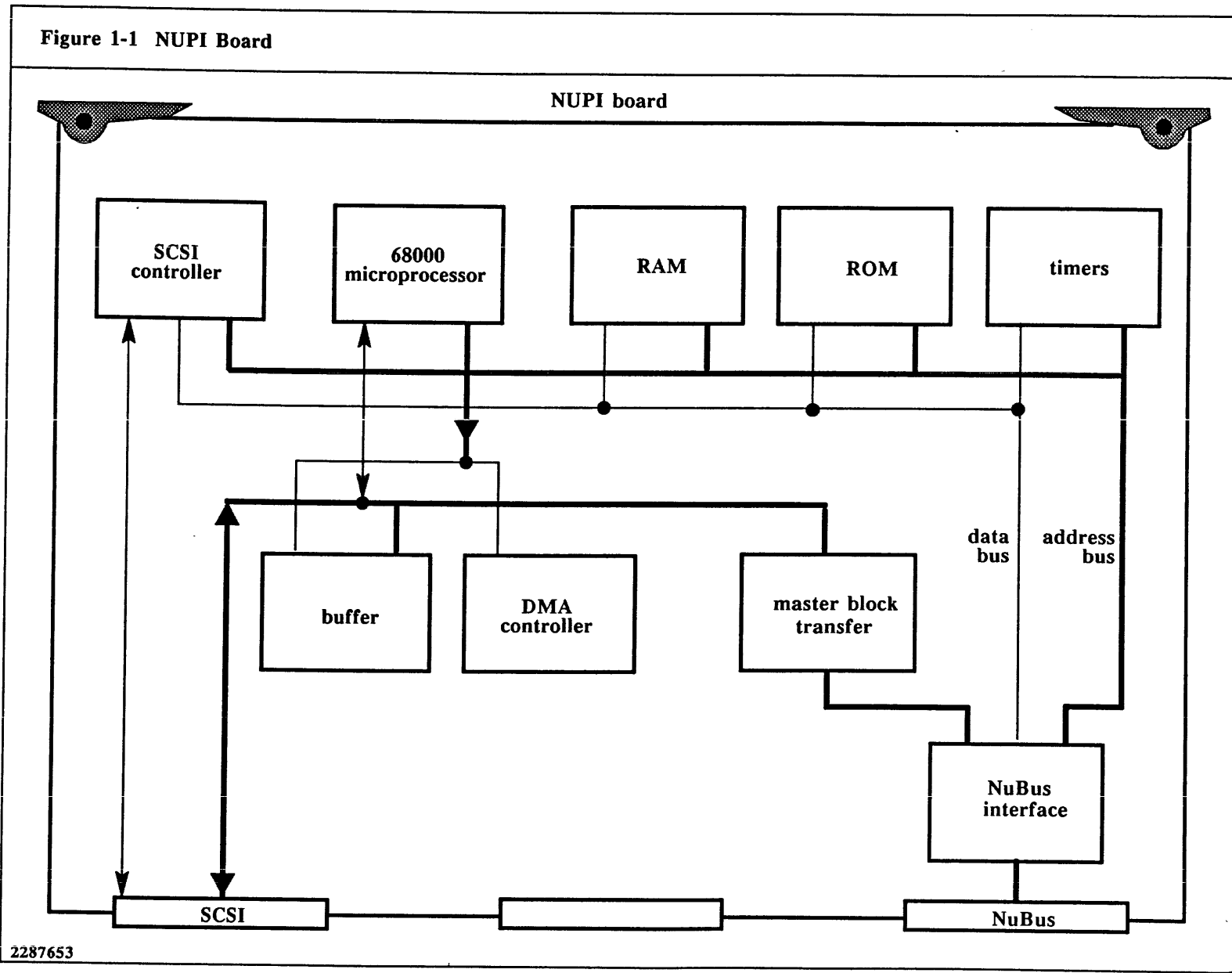

## NUPI UNPACKING

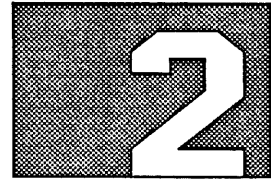

---

### Unpacking the System Board and Associated Cable Adapters

2.1 System owners who install their own system boards and associated cable adapters should perform the following steps to unpack the equipment:

1. Visually inspect the shipping container for damage. If the inspection reveals damage to the shipping container, contact the carrier agent for instructions on filing a claim. The carrier, not Texas Instruments, is responsible for damage during shipment. Resolve all problems relating to shipping damage before proceeding with the installation.
2. Note on the delivery receipt any problems that you discover.
3. Be sure that the driver has signed the delivery receipt.
4. Obtain a knife for cutting the sealing tape that secures the system board and the cable adapter packing containers.

---

**CAUTION:** The system board contains static-sensitive electronic components. To avoid damage to these components, ensure that you are well grounded before handling the system board.

The recommended method is to use a static-control system consisting of a static-control floor or table mat and a static-control wrist strap. These are commercially available. If you do not have a static-control system, you can discharge any accumulated static charge by touching a grounded object prior to handling the system board.

Before storing or transporting the system board, return it to its protective package.

---

---

**WARNING:** Some of the system boards have a lithium battery that will discharge and possibly explode if the positive and negative terminals of the battery are shorted together. **DO NOT** place the system board on a conductive surface, such as the outside surfaces of the static-protective shipping bag, as this can discharge the battery. The outside surface of all static-protective shipping bags are conductive.

---



5. As you unpack the system board (Figure 2-1) and the associated cable adapters (Figure 2-2), inspect the equipment for shipping damage. If the inspection reveals damage that you feel is significant, stop the unpacking procedure and contact the carrier agent. After the carrier agent inspects the damage, contact a Texas Instruments Field Service office. Save all the packing material for future use whenever possible.

Figure 2-1

System Board Shipping Container

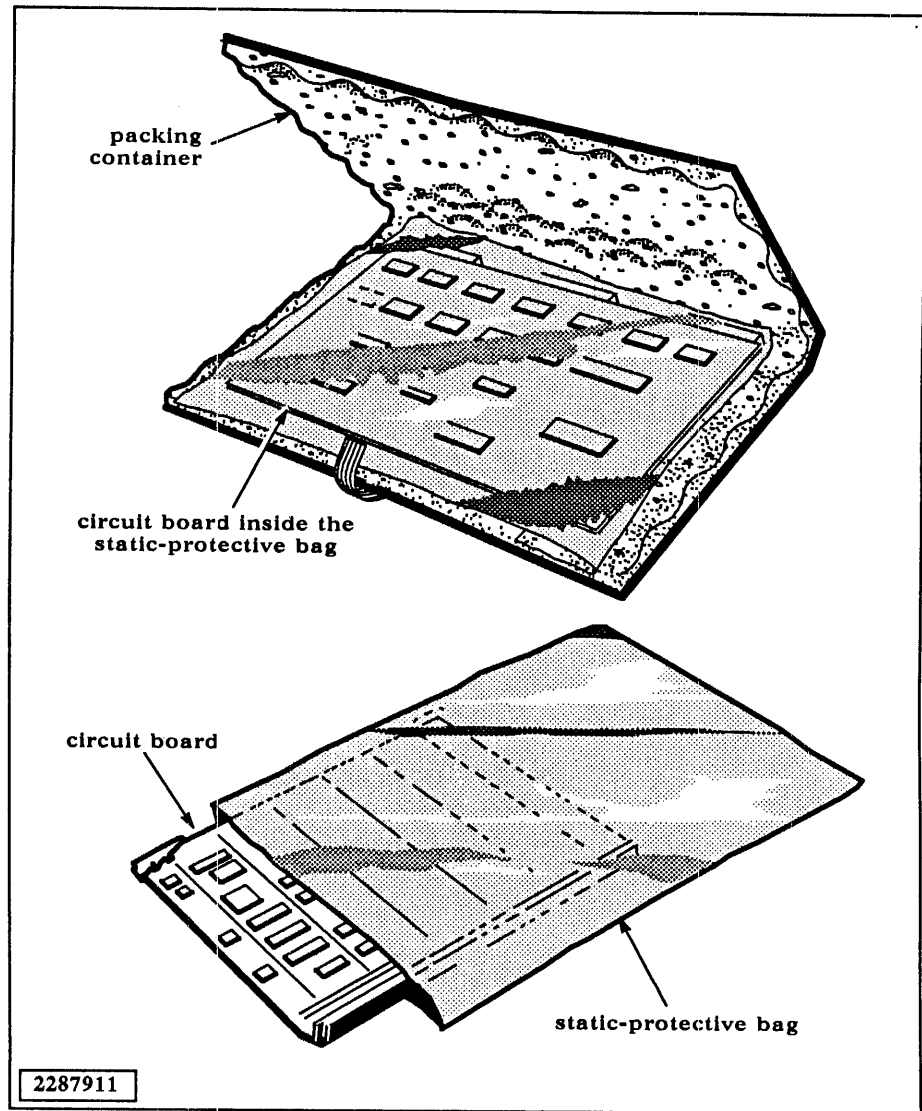
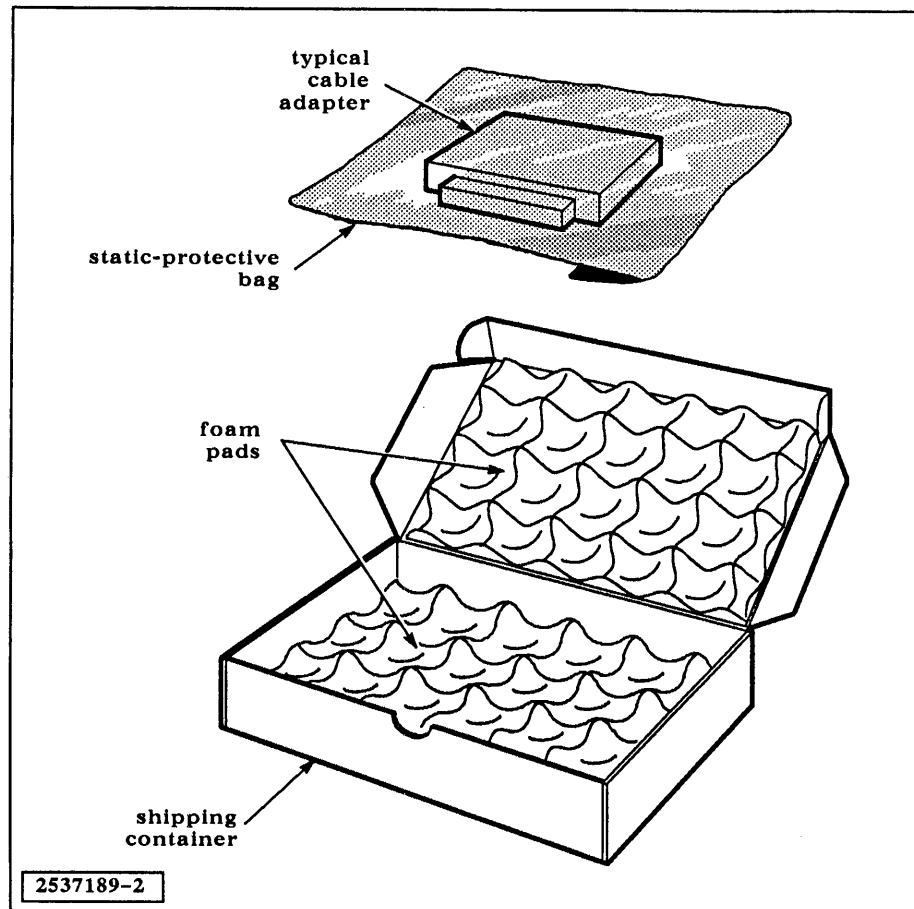
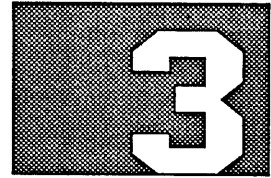

Figure 2-2

Typical Cable Adapter Shipping Container



# NUPI INSTALLATION AND OPERATION



---

## System Board Installation

3.1 The system board may be shipped installed in the enclosure, or depending on your system configuration and options, you may have to install the boards. You also may have to install the system board when upgrading your system.

---

## TI-Installed System Board and Associated Cable Adapters

3.2 The following procedure outlines the tasks you must perform before TI installs your system board and associated cable adapters:

1. Note the serial number on the box that contained this manual.
2. Call the Field Service Communications Center (FSCC) at telephone number 1-800-572-3300 to schedule a site inspection (if required) and the equipment installation. Refer to your system installation manual for site requirements. The following information is required to schedule a TI installation:
  - System/chassis serial number
  - Customer name
  - Customer street address, city, state, and zip code
  - Name and telephone number of customer personnel to contact
  - Purchase order number if the installation was not ordered with the equipment

---

**WARNING:** To eliminate the possibility of electrical shock during option or upgrade installation, you must isolate the system enclosure from all potential energy sources. To isolate the system enclosure:

1. Power off the system enclosure and all peripherals.
  2. Disconnect the power cable from the wall outlet of all local peripherals connected to the system enclosure.
  3. Disconnect all interface cables between the system enclosure and all remote peripherals.
  4. Unplug the system enclosure power cable from the wall outlet.
-

---

**CAUTION:** All boards, options, adapters, and peripherals contain components that are sensitive to static electricity. When handling any of these items, protect against static electricity by using wrist grounding straps, grounded working mats, and antistatic bags for moving or storing the items.

---

Refer to the *Mass Storage Unit (MSU IIA) Installation and Operation* manual for instructions on installing the disk and tape drives.

Access to the system backplane varies with the particular enclosure. Refer to the *Computer Enclosure Installation and Operation* manual for instructions on gaining access to the backplane and on the actual insertion of the NUPI board. After the NUPI board is installed, insert the NUPI adapter into the backplane as follows:

1. Position the adapter so that the shield faces to the left and the 96-pin connector faces toward the backplane at connector P3 of the slot that is associated with the NUPI board.
2. Slide the adapter into the mounting rails until it is seated in connector P3 on the backplane.
3. Attach the SCSI cable, as shown in Figure 3-1.
4. Restore the enclosures to the conditions they were in before you installed the NUPI board and adapter.
5. Use the General Diagnostic Operating System (GDOS), release 2.0.0 or later, to test the operation of the NUPI board and adapter that you just installed.

Figure 3-1 NUPI Board Cabling

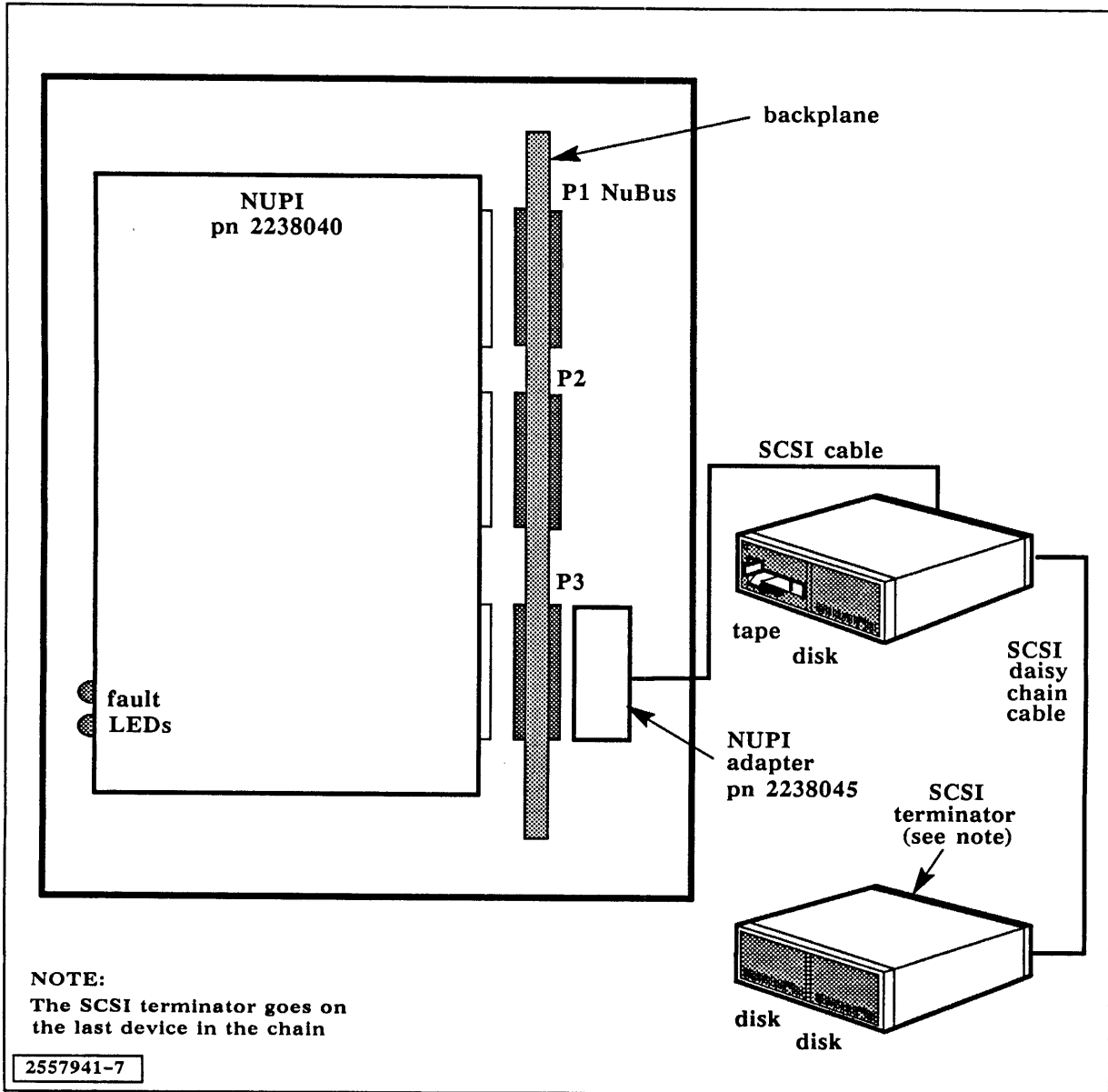

**Operation of the NUPI Board LED Indicators**

3.3 The operation of the NuBus peripheral interface (NUPI) board LEDs is as follows:

- Top — Small computer system interface (SCSI) channel fault
- Bottom — Board fault

# INDEX

---

## B

### boards

general description: *NUPI 1-1-1-2*  
installation: *NUPI 3-1-3-3*  
shipping container: *NUPI 2-2*  
TI installation: *NUPI 3-1-3-3*  
unpacking: *NUPI 2-1-2-3*

## C

### cable adapters

shipping container: *NUPI 2-3*  
TI installation: *NUPI 3-1-3-3*  
unpacking: *NUPI 2-1-2-3*

cautions, static electricity: *NUPI 2-1, 3-2*

## E

electrical shock warning: *NUPI 3-1*

## I

indicators, LED: *NUPI 3-3*

### installation

cable adapters: *NUPI 3-1-3-3*  
cautions: *NUPI 3-2*  
system boards: *NUPI 3-1-3-3*  
warnings: *NUPI 3-1*

## L

LED indicators: *NUPI 3-3*

lithium battery warning: *NUPI 2-1*

## N

### NuBus peripheral interface (NUPI) board

cabling: *NUPI 3-3*  
general description: *NUPI 1-1-1-2*  
installation: *NUPI 3-1-3-3*  
LED indicators: *NUPI 3-3*

## S

### shipping container

cable adapter: *NUPI 2-3*  
system board: *NUPI 2-2*

static electricity caution: *NUPI 2-1, 3-2*

system boards. *See* boards

## T

### TI-installation

cable adapters: *NUPI 3-1-3-3*  
system boards: *NUPI 3-1-3-3*

## U

### unpacking

cable adapters: *NUPI 2-1-2-3*  
cautions: *NUPI 2-1*  
system boards: *NUPI 2-1-2-3*  
warnings: *NUPI 2-1*

## W

### warnings

electrical shock: *NUPI 3-1*  
lithium battery: *NUPI 2-1*

# NUPI-2 BOARD

---

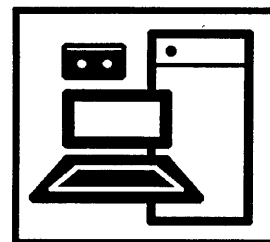





# CONTENTS

---

Paragraph	Title	Page
<b>1</b>	<b>NUPI-2 Overview</b>	
1.1	Introduction .....	1-1
1.2	Features .....	1-2
1.3	Functional Operation .....	1-2
1.4	Specifications .....	1-4
1.5	Reference Documents .....	1-5

---

<b>2</b>	<b>NUPI-2 Unpacking</b>	
2.1	Unpacking the System Board and Associated Cable Adapters .....	2-1

---

<b>3</b>	<b>NUPI-2 Installation and Operation</b>	
3.1	System Board Installation .....	3-1
3.2	TI-Installed System Board and Associated Cable Adapters .....	3-1
3.2.1	Installing the NUPI-2 Board .....	3-2
3.2.2	Installing the SCSI Adapter and Cable .....	3-5
3.3	Operation of the NUPI-2 Board LED Indicators .....	3-5

---

## Index

---

Figure	Title	Page
<b>Figures</b>		
1-1	NUPI-2 Controller Board .....	1-1
1-2	NUPI-2 Controller Block Diagram .....	1-3
2-1	System Board Shipping Container .....	2-2
2-2	Typical Cable Adapter Shipping Container .....	2-3
3-1	NUPI-2 Board Cabling to an MSU .....	3-3
3-2	NUPI-2 Board Cabling to a PE-48 .....	3-4

---

Table	Title	Page
<b>Table</b>		
1-1	Specifications .....	1-4

---



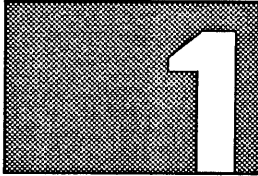

# NUPI-2 OVERVIEW

## Introduction

1.1 The NuBus™ peripheral interface 2 (NUPI-2) controller is also known as the small computer system interface (SCSI) file processor. The NUPI-2 (Figure 1-1), TI part number 2562332-0001, provides a high-performance NuBus-to-SCSI interface with extensive onboard self-testing.

Figure 1-1 NUPI-2 Controller Board

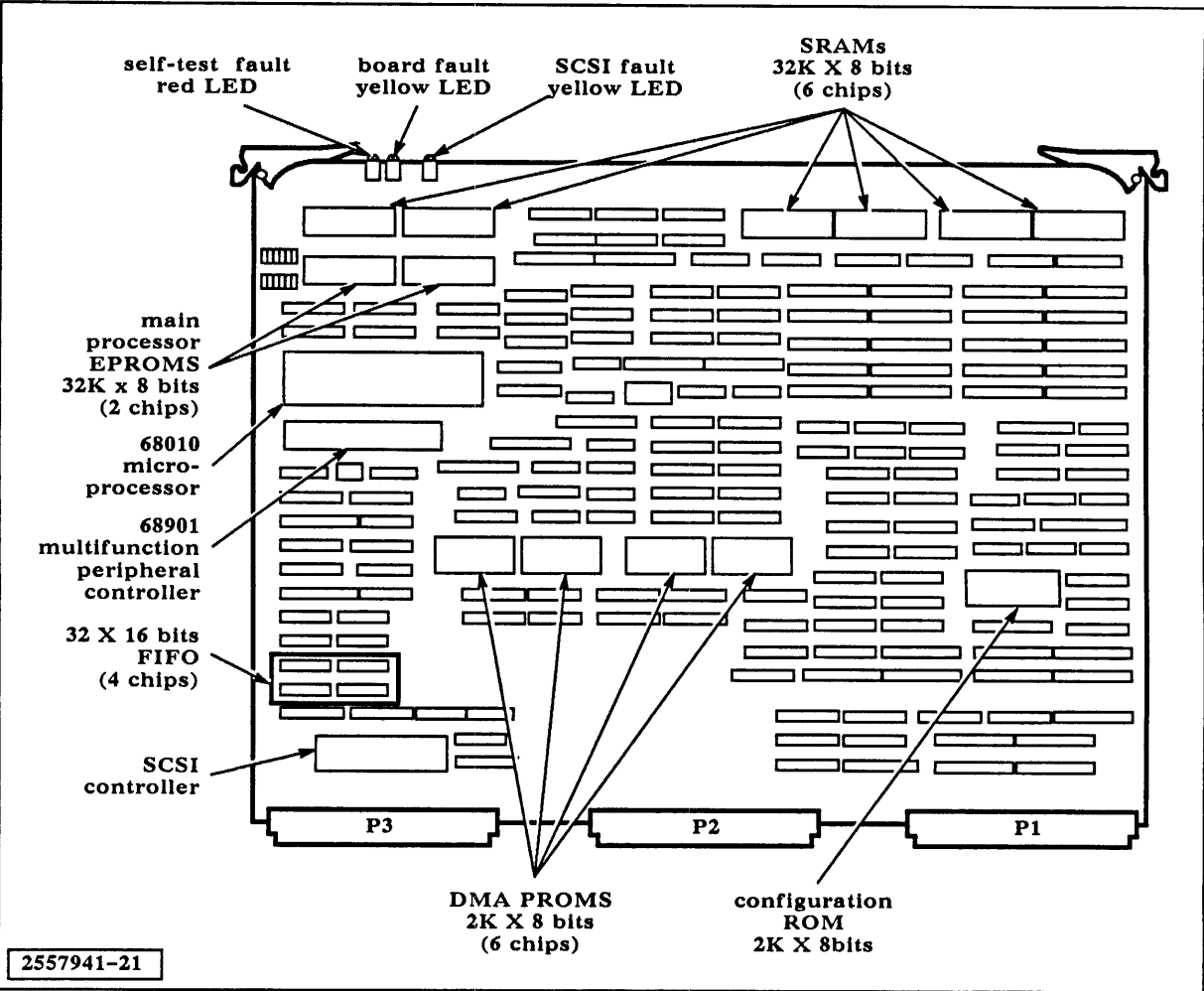

NuBus is a trademark of Texas Instruments Incorporated.

---

**Features**

1.2 The key features of the NUPI-2 are as follows:

- High performance NuBus interface that maximizes data throughput and minimizes command processing overhead
- High performance autonomus direct memory access (DMA) logic for fast onboard data movement
- Extensive onboard self-test diagnostics
- Separate peripheral cable adapter board for connecting connector P3 of the NUPI-2 through the backplane to the peripheral cable
- Full functionality firmware in onboard ROMs
- Supports firmware download to RAMs from operating system
- Supports synchronous and asynchronous protocols
- Supports slave and master NuBus modes
- Contains single-ended SCSI bus drivers/receivers

---

**Functional Operation**

1.3 The major functional operational areas of the NUPI-2 (Figure 1-2) are as follows:

- NuBus interface
- Main microprocessor subsystem
- DMA controller
- SCSI controller

Three internal board buses increase data throughput and minimize command processing overhead. The internal buses are:

- Input/output (I/O) bus — Transfers data to and from the NuBus and other internal NUPI-2 buses.
- Microprocessor bus — Enables processing of data and the command overhead. This bus is the main microprocessor data bus and is separate from the data flow path.
- DMA bus — Maximizes data throughput. This bus is used as an intermediate bus for the normal flow of data.

Figure 1-2 NUPI-2 Controller Block Diagram

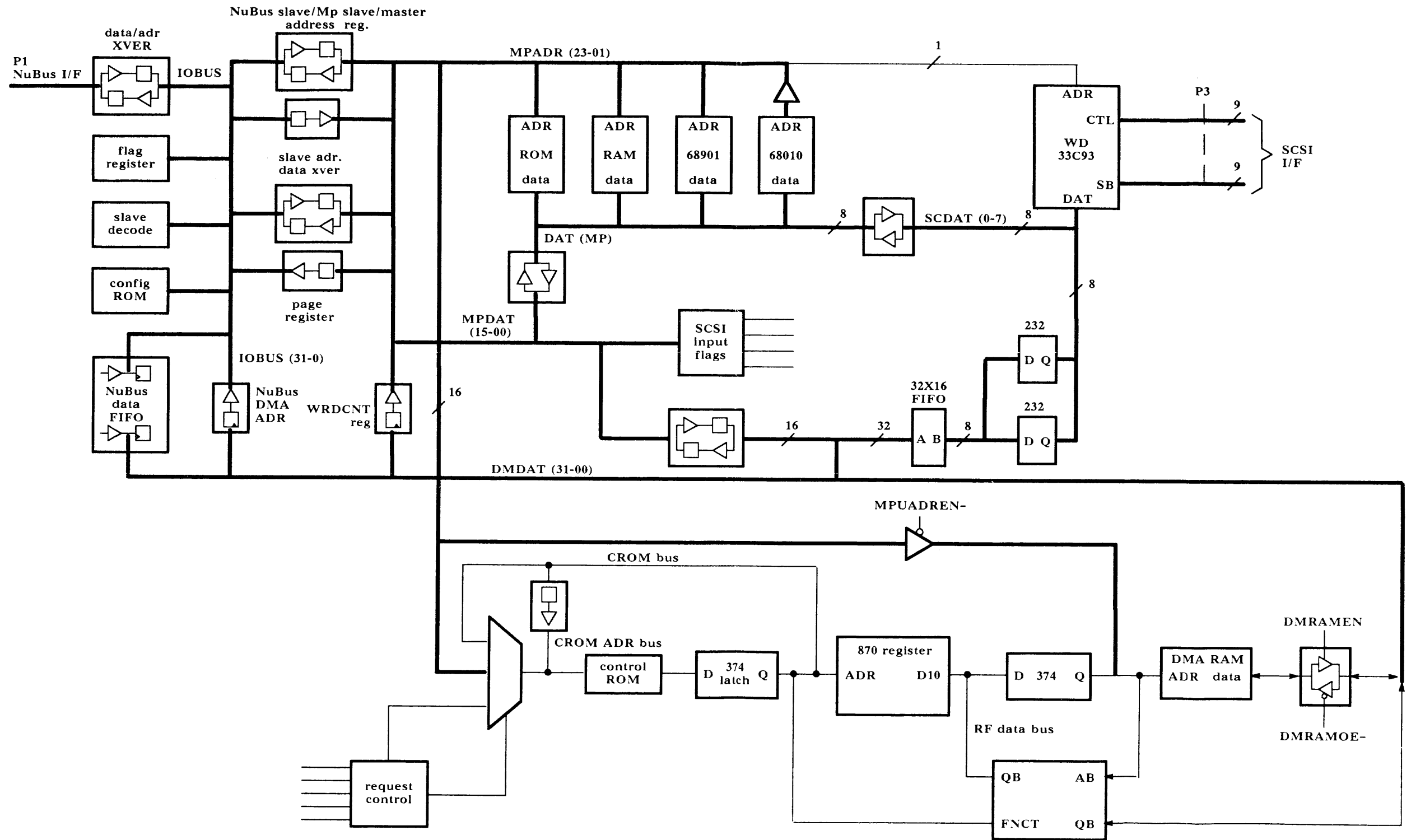

2557941-20

The NUPI-2 operates as a NuBus slave when receiving configuration information and the starting address of a command block and when supplying configuration read-only memory (ROM) information or board status flags.

Commands are initiated by the operating system software writing the starting physical NuBus memory address of the command block to the appropriate NUPI-2 command address register. The NUPI-2 then becomes a NuBus master to obtain the command block and process it.

The NUPI-2 has a 68010 microprocessor that controls all board functions and supports one SCSI data channel. The microprocessor is responsible for setting up the DMA command structures in the DMA memory and processing the DMA interrupts. All SCSI command level operations and NUPI-2 high-level SCSI interface protocols are handled by the microprocessor. The detailed SCSI interface protocol is controlled by the WD33C93 SCSI protocol controller chip.

---

## Specifications

1.4 Table 1-1 lists the hardware specifications of the NUPI-2.

---

**Table 1-1 Specifications**

Item	Specification
Power requirements	8.5 A (typical) at +5 Vdc (+/-5%)
Temperature:	
Operation	5 to 45 degrees C (41 to 113 degrees F)
Nonoperation	-40 to 65 degrees C (-40 to 149 degrees F)
Relative humidity:	
Operating	8 to 80 percent (non-condensing)
Nonoperating	5 to 95 percent (non-condensing)
68010 microprocessor operating speed	10 MHz
NuBus to SCSI throughput rate	Up to 4.4 megabytes per second
NuBus master block mode burst rate	37.5 megabytes per second

---

---

**Reference Documents**

1.5 For additional technical information on the NUPI-2 controller, refer to the following documents:

- *IEEE Standard for a Simple 32-Bit Backplane Bus: NuBus*, IEEE Standard 1196-1987, (Institute of Electrical and Electronics Engineers, Inc.)
- *NuBus System Architecture General Description*, TI part number 2537171-0001
- *TI System V Administrator's Guide*, TI part number 2540539-0001
- *NuBus Systems System 1500 Field Maintenance Handbook*, TI part number 2549258-0001

## NUPI-2 UNPACKING

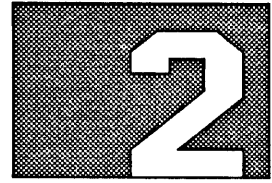

---

### Unpacking the System Board and Associated Cable Adapters

2.1 System owners who install their own system boards and associated cable adapters should perform the following steps to unpack the equipment:

1. Visually inspect the shipping container for damage. If the inspection reveals damage to the shipping container, contact the carrier agent for instructions on filing a claim. The carrier, not Texas Instruments, is responsible for damage during shipment. Resolve all problems relating to shipping damage before proceeding with the installation.
2. Note on the delivery receipt any problems that you discover.
3. Be sure that the driver has signed the delivery receipt.
4. Obtain a knife for cutting the sealing tape that secures the system board and the cable adapter packing containers.

---

**CAUTION:** The system board contains static-sensitive electronic components. To avoid damage to these components, ensure that you are well grounded before handling the system board.

The recommended method is to use a static-control system consisting of a static-control floor or table mat and a static-control wrist strap. These are commercially available. If you do not have a static-control system, you can discharge any accumulated static charge by touching a grounded object prior to handling the system board.

Before storing or transporting the system board, return it to its protective package.

---

---

**WARNING:** Some of the system boards have a lithium battery that will discharge and possibly explode if the positive and negative terminals of the battery are shorted together. DO NOT place the system board on a conductive surface, such as the outside surfaces of the static-protective shipping bag, as this can discharge the battery. The outside surface of all static-protective shipping bags is conductive.

---



5. As you unpack the system board (Figure 2-1) and the associated cable adapters (Figure 2-2), inspect the equipment for shipping damage. If the inspection reveals damage that you feel is significant, stop the unpacking procedure and contact the carrier agent. After the carrier agent inspects the damage, contact a Texas Instruments Field Service office. Save all the packing material for future use whenever possible.

Figure 2-1

System Board Shipping Container

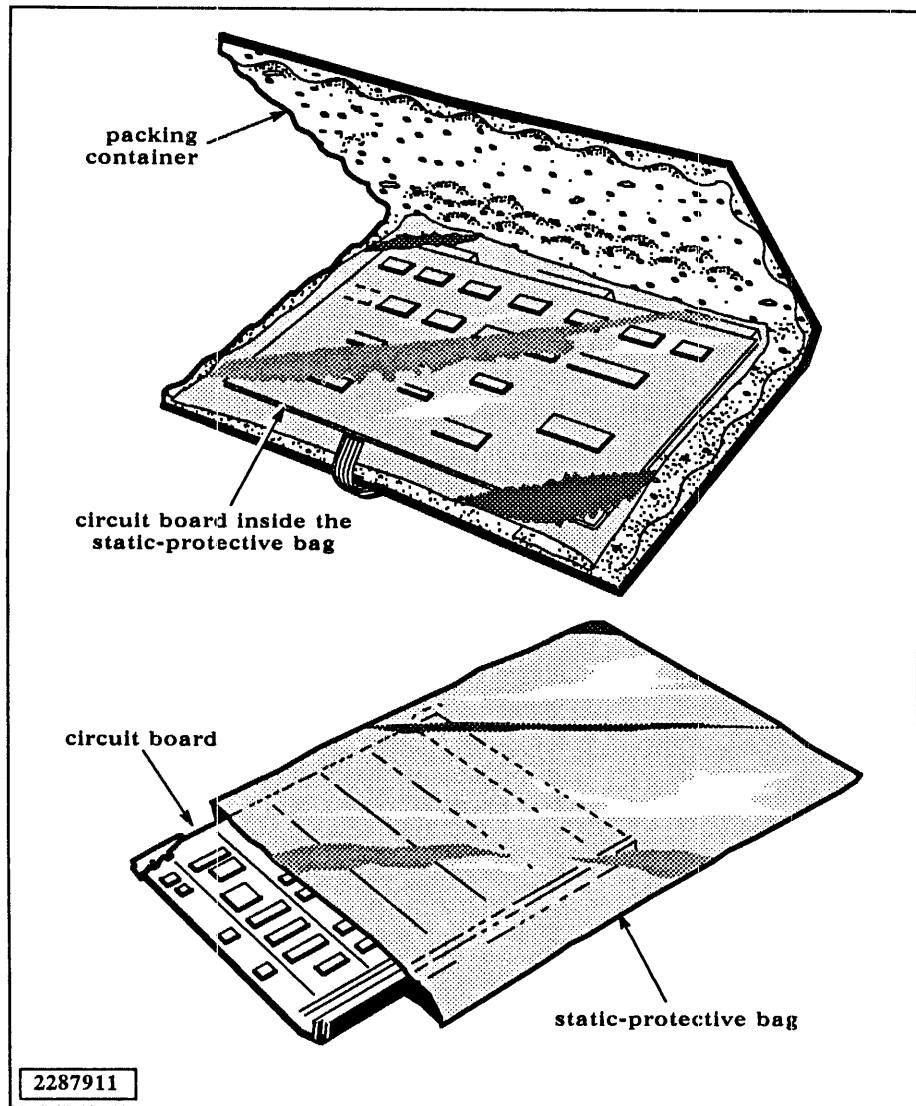
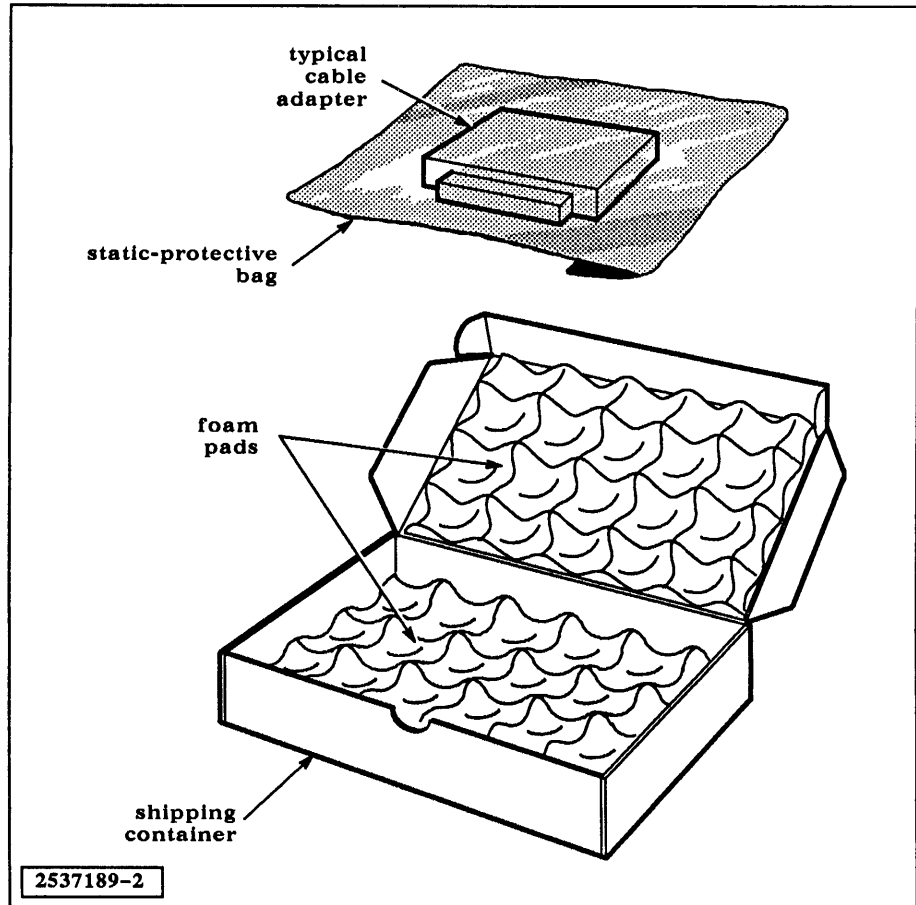
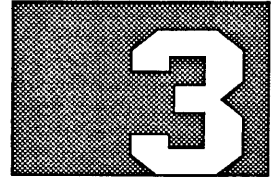

Figure 2-2

Typical Cable Adapter Shipping Container



# NUPI-2 INSTALLATION AND OPERATION



---

## System Board Installation

3.1 The system board may be shipped installed in the enclosure, or depending on your system configuration and options, you may have to install the boards. You also may have to install the system board when upgrading your system.

---

## TI-Installed System Board and Associated Cable Adapters

3.2 The following procedure outlines the tasks you must perform before TI installs your system board and associated cable adapters:

1. Note the serial number on the box that contained this manual.
2. Call the Field Service Communications Center (FSCC) at telephone number 1-800-572-3300 to schedule a site inspection (if required) and the equipment installation. Refer to your system installation manual for site requirements. The following information is required to schedule a TI installation:
  - System serial number
  - Customer name
  - Customer street address, city, state, and zip code
  - Name and telephone number of customer personnel to contact
  - Purchase order number if the installation was not ordered with the equipment

---

**WARNING:** To eliminate the possibility of electrical shock during option or upgrade installation, you must isolate the system enclosure from all potential energy sources. To isolate the system enclosure:

1. Power off the system enclosure and all peripherals.
  2. Disconnect the power cable from the wall outlet of all local peripherals connected to the system enclosure.
  3. Disconnect all interface cables between the system enclosure and all remote peripherals.
  4. Unplug the system enclosure power cable from the wall outlet.
-

---

**CAUTION:** All boards, options, adapters, and peripherals contain components that are sensitive to static electricity. When handling any of these items, protect against static electricity by using wrist grounding straps, grounded working mats, and antistatic bags for moving or storing the items.

---

**Installing the  
NUPI-2 Board**

---

**3.2.1** For software transportability, all System 1500 systems have at least one SCSI device, the CT60/CT150 tape drive. Figures 3-1 and 3-2 show the NUPI-2 with the SCSI adapter installed and connected to mass storage unit and the 48-inch peripheral enclosure (PE-48), respectively.

Access to the system backplane varies with the particular enclosure. Refer to the *Computer Enclosure Installation and Operation* manual for instructions on gaining access to the backplane and the actual insertion of the NUPI-2 board.

Refer to the following manual for instructions on installing the enclosures with the disk and tape drives:

- *Mass Storage Unit (MSU IIA) Installation and Operation*
- *Peripheral Enclosure Installation and Operation*

Figure 3-1 NUPI-2 Board Cabling to an MSU

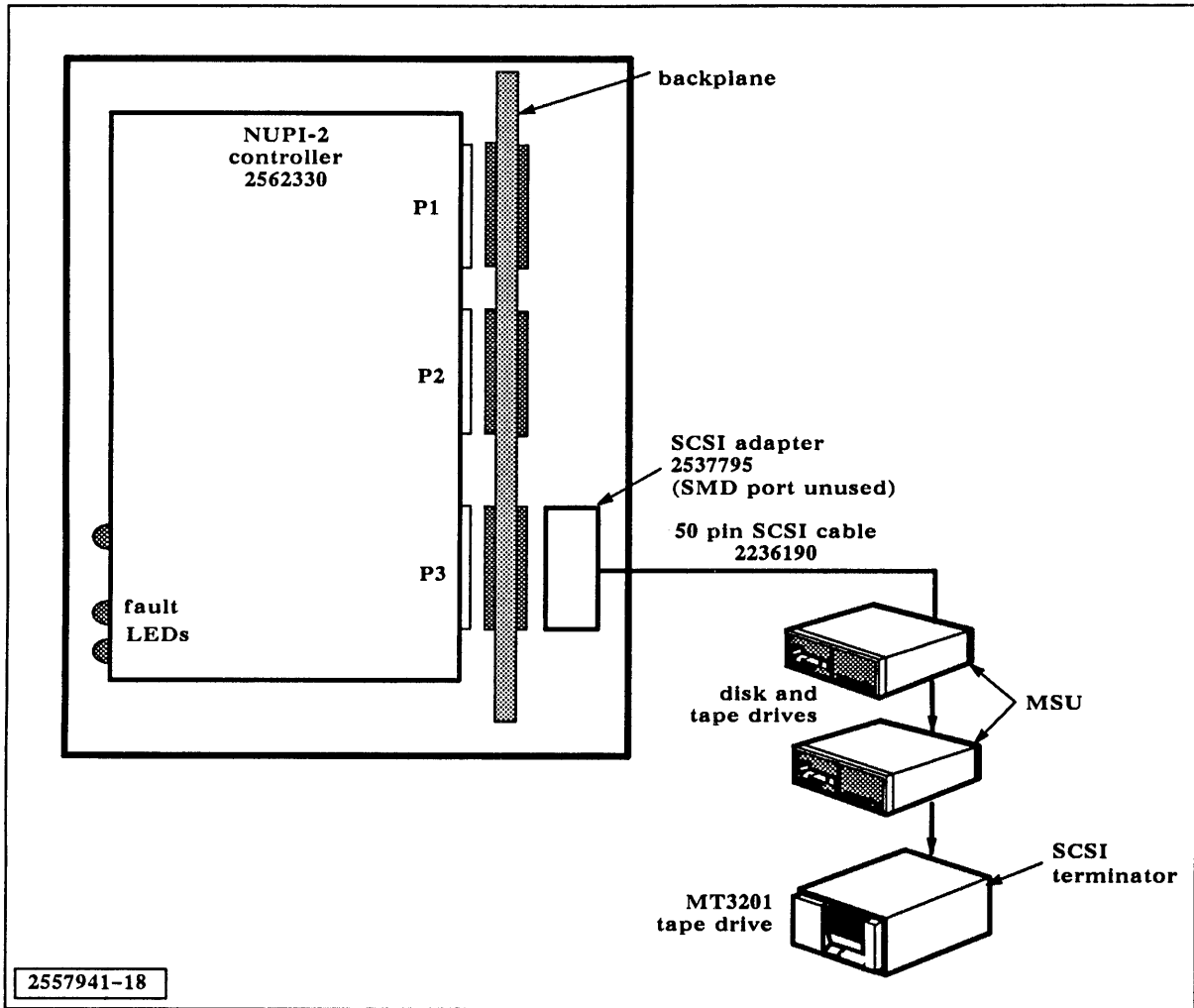
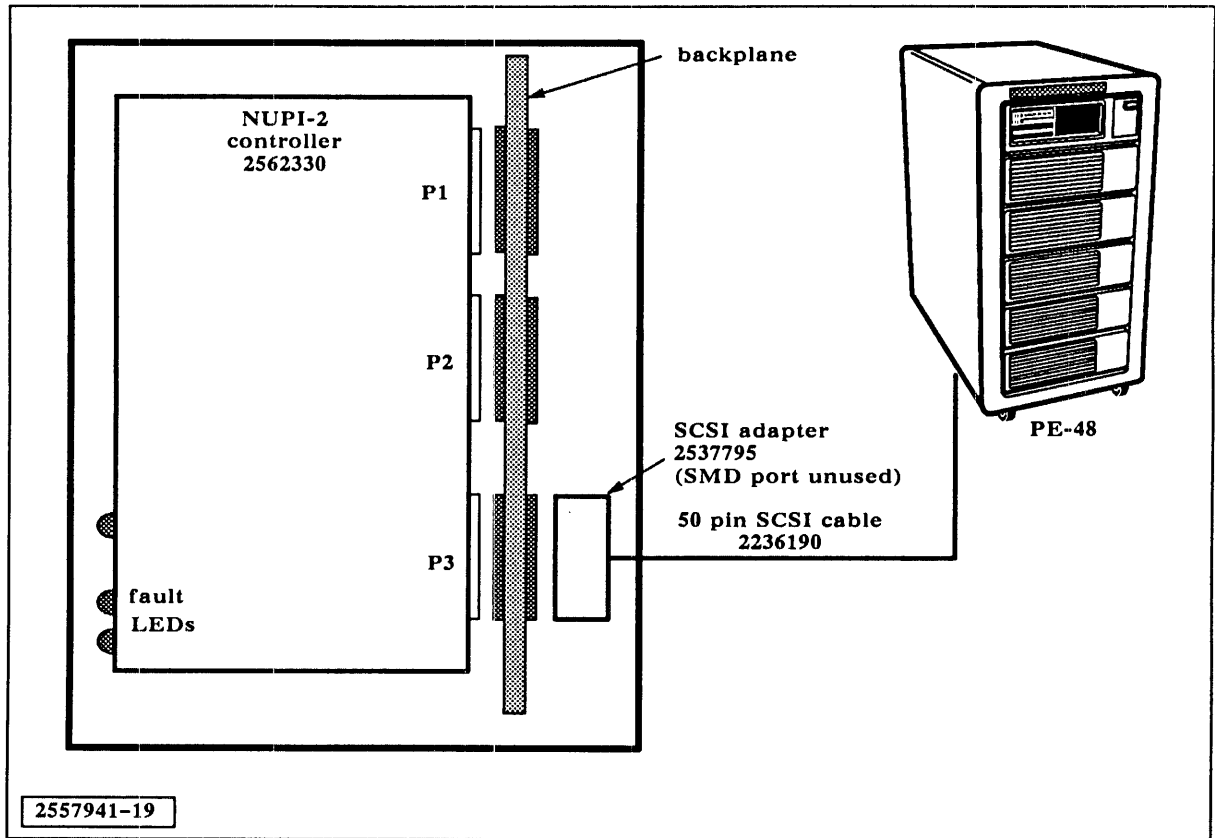

Figure 3-2 NUPI-2 Board Cabling to a PE-48



---

**Installing the SCSI Adapter and Cable**

**3.2.2** To install the SCSI adapter on the NUPI-2:

1. Refer to the *Computer Enclosure Installation and Operation* manual for instructions on gaining access to the backplane.
2. Position the SCSI adapter with the 96-pin connector facing the backplane and the adapter cover facing to the left.
3. Slide the SCSI adapter into the P3 (bottom) connector of the slot containing the NUPI-2 board.
4. Attach the SCSI interface cable to the SCSI adapter, and route the interface cable out the bottom of the system enclosure.
5. Restore the enclosures to the conditions they were in prior to installing the SCSI adapter.
6. Use the General Diagnostic Operating System (GDOS), release 2.0.0 or later, to test the operation of the SCSI adapter that you just installed.

---

**Operation of the NUPI-2 Board LED Indicators**

**3.3** The operation of the NUPI-2 LEDs is as follows:

- Top — SCSI channel fault (yellow)
- Center — Board fault (yellow)
- Bottom — Fault (red)

# INDEX

---

## B

### boards

general description: *NUPI-2* 1-1-1-5  
installation: *NUPI-2* 3-1-3-5  
shipping container: *NUPI-2* 2-2  
TI installation: *NUPI-2* 3-1-3-5  
unpacking: *NUPI-2* 2-1-2-3

## C

### cable adapters

shipping container: *NUPI-2* 2-3  
TI installation: *NUPI-2* 3-1-3-5  
unpacking: *NUPI-2* 2-1-2-3

cautions, static electricity: *NUPI-2* 2-1, 3-2

## E

electrical shock warning: *NUPI-2* 3-1

## I

indicators, LED: *NUPI-2* 3-5

### installation

cable adapters: *NUPI-2* 3-1-3-5  
cautions: *NUPI-2* 3-2  
system boards: *NUPI-2* 3-1-3-5  
warnings: *NUPI-2* 3-1

## L

LED indicators: *NUPI-2* 3-5

lithium battery warning: *NUPI-2* 2-1

## M

### mass storage controller (MSC)

general description: *NUPI-2* 1-1-1-5  
SCSI adapter and cable installation:  
*NUPI-2* 3-5

## N

### NUPI-2

board installation: *NUPI-2* 3-2-3-4  
LED indicators: *NUPI-2* 3-5

## R

reference documents: *NUPI-2* 1-5

## S

### shipping container

cable adapter: *NUPI-2* 2-3  
system board: *NUPI-2* 2-2

### small computer system interface (SCSI)

adapter and cable installation: *NUPI-2*  
3-5

specifications: *NUPI-2* 1-4

static electricity caution: *NUPI-2* 2-1, 3-2

system boards. *See* boards

## T

### TI-installation

cable adapters: *NUPI-2* 3-1-3-5  
system boards: *NUPI-2* 3-1

## U

### unpacking

cable adapters: *NUPI-2* 2-1-2-3  
cautions: *NUPI-2* 2-1  
system boards: *NUPI-2* 2-1-2-3  
warnings: *NUPI-2* 2-1

## W

### warnings

electrical shock: *NUPI-2* 3-1  
lithium battery: *NUPI-2* 2-1



# MASS STORAGE CONTROLLER

---

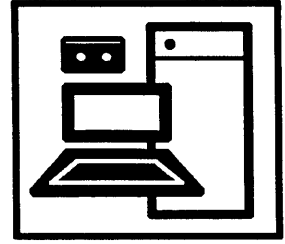



# CONTENTS

---

Paragraph	Title	Page
<b>1</b>	<b>Mass Storage Controller</b>	
1.1	Introduction .....	1-1
<b>2</b>	<b>MSC Unpacking</b>	
2.1	Unpacking the System Board and Associated Cable Adapters .....	2-1
<b>3</b>	<b>MSC Installation and Operation</b>	
3.1	System Board Installation .....	3-1
3.2	TI-Installed System Board and Associated Cable Adapters .....	3-1
3.2.1	Installing the MSC Board .....	3-2
3.2.2	Installing the SCSI Adapter and Cable .....	3-4
3.2.3	Installing the SMD Adapter and Cable .....	3-4
3.3	Operation of the MSC Board LED Indicators .....	3-4

---

## Index

---

Figure	Title	Page
<b>Figures</b>		
1-1	Mass Storage Controller .....	1-3
2-1	System Board Shipping Container .....	2-2
2-2	Typical Cable Adapter Shipping Container .....	2-3
3-1	MSC Board Cabling to a TDE II and MSU .....	3-3
3-2	MSC Board Cabling to a PE-48 .....	3-4

---



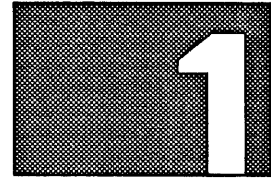

# MASS STORAGE CONTROLLER

---

## Introduction

1.1 The mass storage controller (MSC) uses two 68010 microprocessors to achieve high-performance, to provide the NuBus™-to-small computer system interface (SCSI) and NuBus-to-storage module drive (SMD) interface, to move onboard data fast with autonomous direct memory access (DMA), and to provide extensive onboard self-testing. The two microprocessors are called the main microprocessor and the SMD microprocessor.

The MSC operates as a NuBus slave when receiving configuration information and the starting address of a command block and when supplying configuration read-only memory (ROM) information or board status flags.

Commands are initiated by the operating system software writing the starting physical NuBus memory address of the command block to the appropriate MSC command address register. The MSC then becomes a NuBus master to obtain the command block and process it.

The major functional areas of the MSC, shown in Figure 1-1, include the following:

- NuBus interface
- Main microprocessor subsystem
- DMA controller
- SCSI controller
- SMD microprocessor subsystem
- SMD controller

Three internal board buses increase data throughput and minimize command processing overhead. The buses are:

- Input/output (I/O) bus — Transfers data to and from the NuBus and other internal MSC buses.
- Microprocessor bus — Enables processing of data and the command overhead. This bus is the main microprocessor data bus and is separate from the data flow path.
- DMA bus — Maximizes data throughput. This bus is used as an intermediate bus for the normal flow of data.

NuBus is a trademark of Texas Instruments Incorporated.

The MSC contains two 68010 microprocessors and supports one SCSI data channel and one SMD data channel. The main microprocessor controls all board functions except the interfacing to the SMD data channel. SMD data coming from the NuBus is sent by the main microprocessor to the second microprocessor, which controls the interface between the MSC and the SMD devices. The main microprocessor is responsible for setting up the DMA command structures in the DMA memory and processing the DMA interrupts. All SCSI command level operations and MSC high-level SCSI interface protocols are handled by the main microprocessor. The detailed SCSI interface protocol is controlled by the WD33C93 SCSI protocol controller chip.

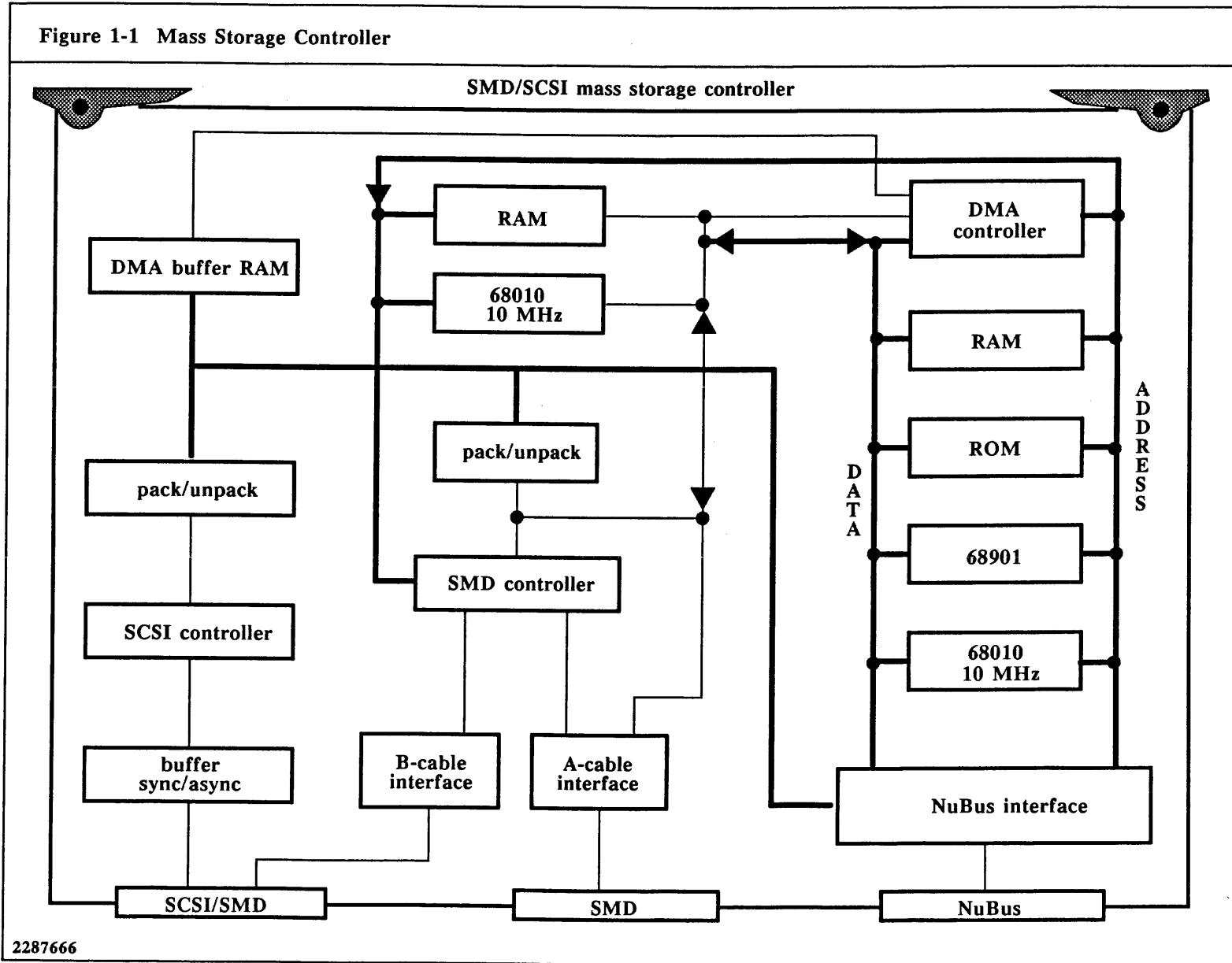

## MSC UNPACKING

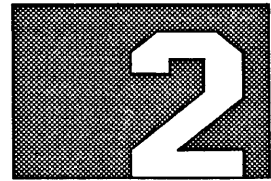

### Unpacking the System Board and Associated Cable Adapters

2.1 System owners who install their own system boards and associated cable adapters should perform the following steps to unpack the equipment:

1. Visually inspect the shipping container for damage. If the inspection reveals damage to the shipping container, contact the carrier agent for instructions on filing a claim. The carrier, not Texas Instruments, is responsible for damage during shipment. Resolve all problems relating to shipping damage before proceeding with the installation.
2. Note on the delivery receipt any problems that you discover.
3. Be sure that the driver has signed the delivery receipt.
4. Obtain a knife for cutting the sealing tape that secures the system board and the cable adapter packing containers.

---

**CAUTION:** The system board contains static-sensitive electronic components. To avoid damage to these components, ensure that you are well grounded before handling the system board.

The recommended method is to use a static-control system consisting of a static-control floor or table mat and a static-control wrist strap. These are commercially available. If you do not have a static-control system, you can discharge any accumulated static charge by touching a grounded object prior to handling the system board.

Before storing or transporting the system board, return it to its protective package.

---

---

**WARNING:** Some of the system boards have a lithium battery that will discharge and possibly explode if the positive and negative terminals of the battery are shorted together. **DO NOT** place the system board on a conductive surface, such as the outside surfaces of the static-protective shipping bag, as this can discharge the battery. The outside surface of all static-protective shipping bags are conductive.

---



5. As you unpack the system board (Figure 2-1) and the associated cable adapters (Figure 2-2), inspect the equipment for shipping damage. If the inspection reveals damage that you feel is significant, stop the unpacking procedure and contact the carrier agent. After the carrier agent inspects the damage, contact a Texas Instruments Field Service office. Save all the packing material for future use whenever possible.

Figure 2-1

System Board Shipping Container

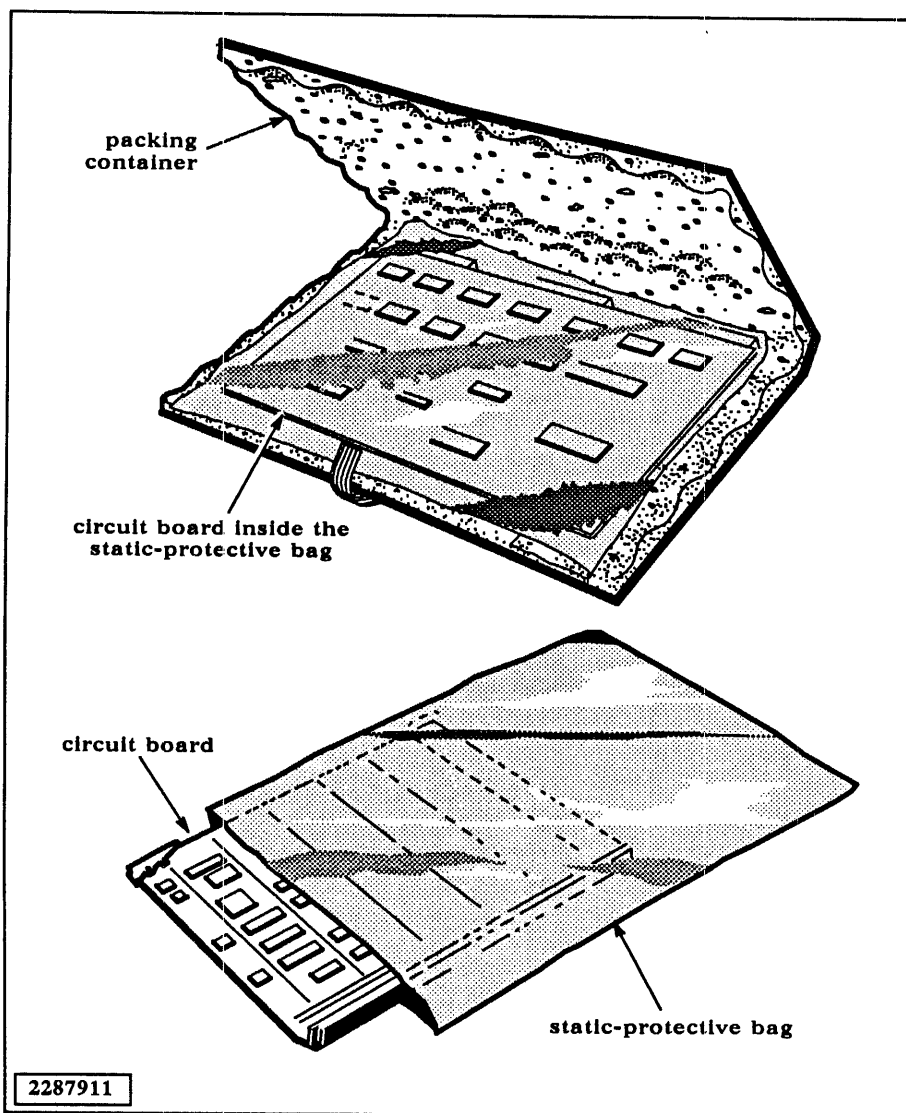
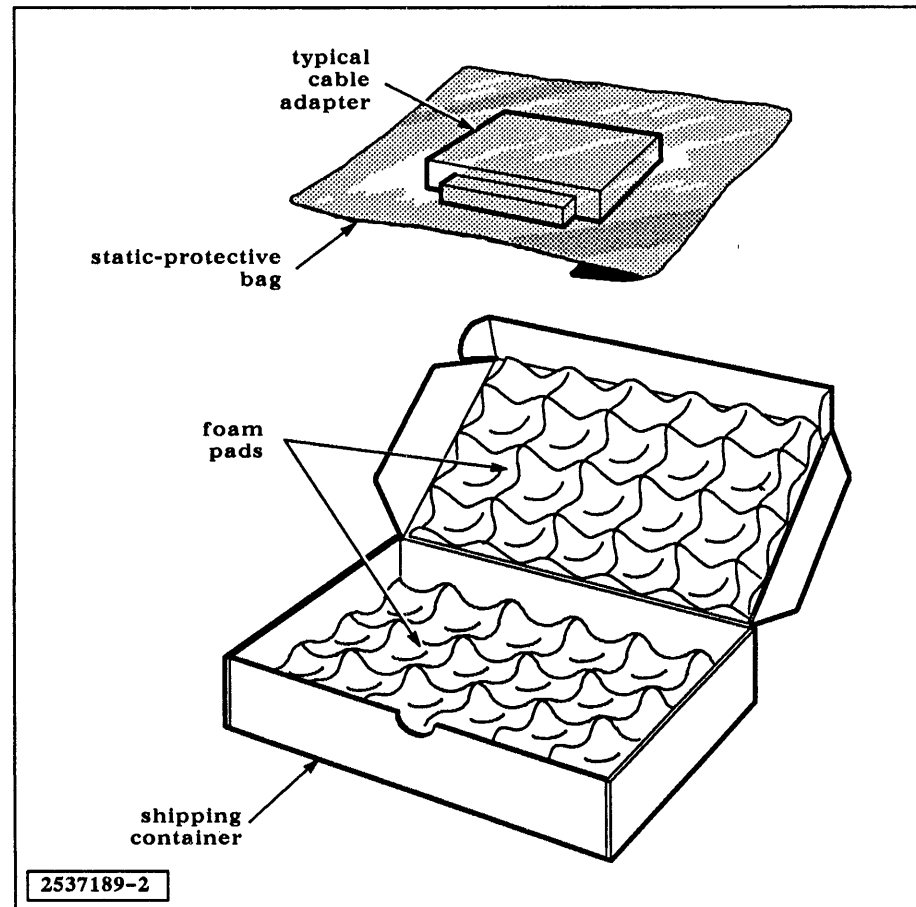
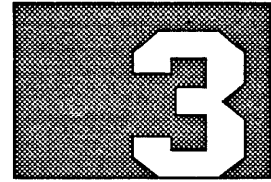

Figure 2-2

Typical Cable Adapter Shipping Container



# MSC INSTALLATION AND OPERATION



---

## System Board Installation

3.1 The system board may be shipped installed in the enclosure, or depending on your system configuration and options, you may have to install the boards. You also may have to install the system board when upgrading your system.

---

## TI-Installed System Board and Associated Cable Adapters

3.2 The following procedure outlines the tasks you must perform before TI installs your system board and associated cable adapters:

1. Note the serial number on the box that contained this manual.
2. Call the Field Service Communications Center (FSCC) at telephone number 1-800-572-3300 to schedule a site inspection (if required) and the equipment installation. Refer to your system installation manual for site requirements. The following information is required to schedule a TI installation:
  - System serial number
  - Customer name
  - Customer street address, city, state, and zip code
  - Name and telephone number of customer personnel to contact
  - Purchase order number if the installation was not ordered with the equipment

---

**WARNING:** To eliminate the possibility of electrical shock during option or upgrade installation, you must isolate the system enclosure from all potential energy sources. To isolate the system enclosure:

1. Power off the system enclosure and all peripherals.
  2. Disconnect the power cable from the wall outlet of all local peripherals connected to the system enclosure.
  3. Disconnect all interface cables between the system enclosure and all remote peripherals.
  4. Unplug the system enclosure power cable from the wall outlet.
-

---

**CAUTION:** All boards, options, adapters, and peripherals contain components that are sensitive to static electricity. When handling any of these items, protect against static electricity by using wrist grounding straps, grounded working mats, and antistatic bags for moving or storing the items.

---

**Installing the  
MSC Board**

---

3.2.1 The mass storage controller (MSC) contains both a small computer system interface (SCSI) and a storage module drive (SMD) interface. For software transportability all System 1500 systems have at least one SCSI device, the CT60 tape drive. Figures 3-1 and 3-2 show the MSC with both the SCSI and SMD adapters installed and connected to the tower disk enclosure II (TDE II) and the 48-inch peripheral enclosure (PE-48.)

Access to the system backplane varies with the particular enclosure. Refer to the *Computer Enclosure Installation and Operation* manual for instructions on gaining access to the backplane and the actual insertion of the MSC board.

Refer to the following manual for instructions on installing the enclosures with the disk and tape drives:

- *Mass Storage Unit (MSU IIA) Installation and Operation*
- *Peripheral Enclosure Installation and Operation*

Figure 3-1 MSC Board Cabling to a TDE II and MSU

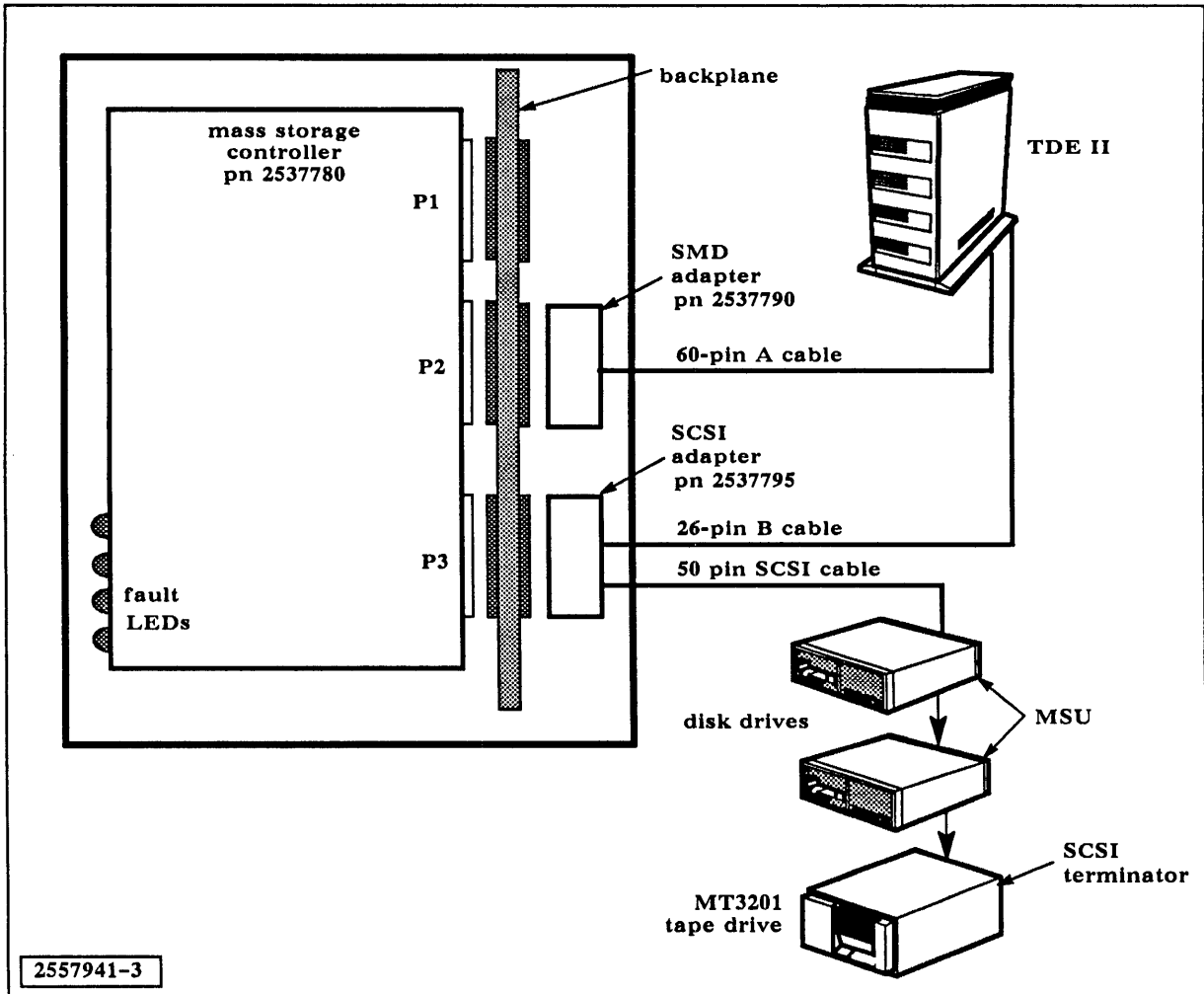
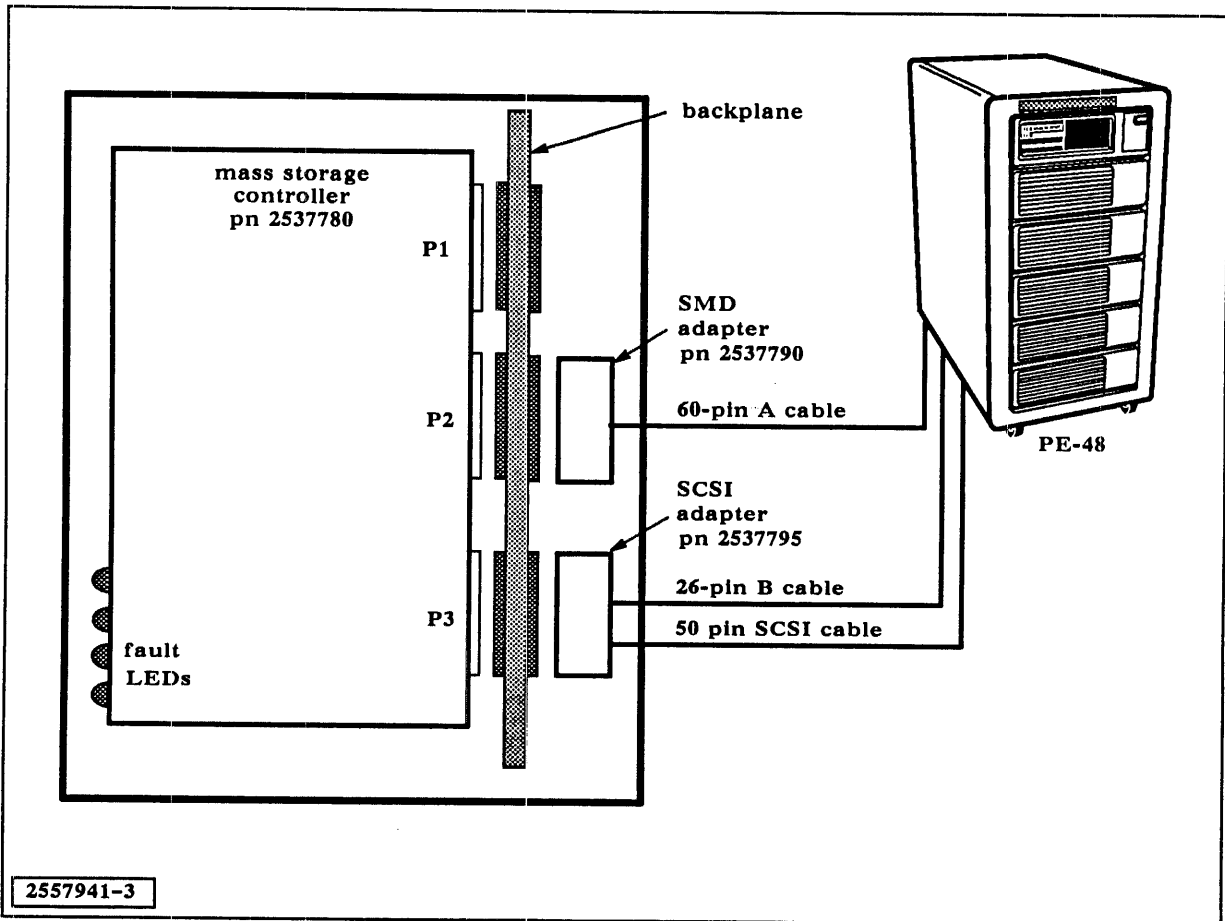

Figure 3-2 MSC Board Cabling to a PE-48



---

**Installing the SCSI Adapter and Cable****3.2.2** To install the SCSI adapter on the MSC:

1. Refer to the *Computer Enclosure Installation and Operation* manual for instructions on gaining access to the backplane.
2. Position the SCSI adapter with the 96-pin connector facing the backplane and the adapter cover facing to the left.
3. Slide the SCSI adapter into the P3 (bottom) connector of the slot containing the MSC board.
4. Attach the SCSI interface cable to the SCSI adapter, and route the interface cable out the bottom of the system enclosure.
5. If you are also installing the SMD adapter, go to step two of the next paragraph. If you are not installing the SMD, proceed with the next step.
6. Restore the enclosures to the conditions they were in prior to installing the SCSI adapter.
7. Use the General Diagnostic Operating System (GDOS), release 2.0.0 or later, to test the operation of the SCSI adapter that you just installed.

---

**Installing the SMD Adapter and Cable****3.2.3** To install the SMD adapter on the MSC:

1. Refer to the *Computer Enclosure Installation and Operation* manual for instructions on gaining access to the backplane.
2. Position the SMD adapter with the 96-pin connector facing the backplane and the adapter cover facing to the left.
3. Slide the SMD adapter into the P2 (middle) connector of the slot containing the MSC board.
4. Attach the 26-pin SMD cable to the small connector located on P3. Attach the SMD interface cable (60 pin) to the SMD adapter, and route the interface cable out the bottom of the system enclosure.
5. Restore the enclosures to the conditions they were in prior to installing the SMD adapter.
6. Use the General Diagnostic Operating System (GDOS), release 2.0.0 or later, to test the operation of the SMD adapter that you just installed.

---

**Operation of the MSC Board LED Indicators****3.3** The operation of the MSC LEDs is as follows:

- Top — SMD channel fault
- Center top — SCSI channel fault
- Center bottom — Board fault
- Bottom — Fault

# INDEX

---

## B

### boards

general description: *MSC 1-1-1-3*  
installation: *MSC 3-1-3-5*  
shipping container: *MSC 2-2*  
TI installation: *MSC 3-1-3-5*  
unpacking: *MSC 2-1-2-3*

## C

### cable adapters

shipping container: *MSC 2-3*  
TI installation: *MSC 3-1-3-5*  
unpacking: *MSC 2-1-2-3*

cautions, static electricity: *MSC 2-1, 3-2*

## E

electrical shock warning: *MSC 3-1*

## I

indicators, LED: *MSC 3-5*

### installation

cable adapters: *MSC 3-1-3-5*  
cautions: *MSC 3-2*  
system boards: *MSC 3-1-3-5*  
warnings: *MSC 3-1*

## L

LED indicators: *MSC 3-5*

lithium battery warning: *MSC 2-1*

## M

mass storage controller (MSC)

board installation: *MSC 3-2-3-4*  
functional areas: *MSC 1-1*

general description: *MSC 1-1-1-3*

LED indicators: *MSC 3-5*

SCSI adapter and cable installation: *MSC 3-5*

SMD adapter and cable installation: *MSC 3-5*

## S

### shipping container

cable adapter: *MSC 2-3*

system board: *MSC 2-2*

### small computer system interface (SCSI)

adapter and cable installation: *MSC 3-5*

static electricity caution: *MSC 2-1, 3-2*

storage module drive (SMD) adapter and cable installation: *MSC 3-5*

system boards. *See* boards

## T

### TI-installation

cable adapters: *MSC 3-1-3-5*

system boards: *MSC 3-1*

## U

### unpacking

cable adapters: *MSC 2-1-2-3*

cautions: *MSC 2-1*

system boards: *MSC 2-1-2-3*

warnings: *MSC 2-1*

## W

### warnings

electrical shock: *MSC 3-1*

lithium battery: *MSC 2-1*



**COMMUNICATION  
PROCESSOR BOARDS**

---

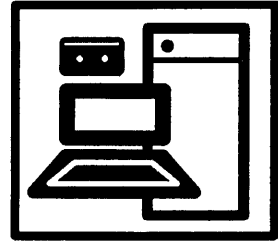



# CONTENTS

---

Paragraph	Title	Page
<b>1</b>	<b>General Description</b>	
1.1	Introduction .....	1-1
1.2	Communications Carrier Board .....	1-5
1.3	Communication Processor II Board .....	1-5
<b>2</b>	<b>Unpacking the Board</b>	
2.1	Unpacking the System Board and Associated Cable Adapters .....	2-1
<b>3</b>	<b>Communication Processor Installation</b>	
3.1	Introduction .....	3-1
3.2	Installing the Board and its Associated Options .....	3-1
3.2.1	4-Channel Asynchronous Option Module .....	3-3
3.2.2	8-Channel Asynchronous Option Module .....	3-6
3.2.3	LAN 802.3 Option Module .....	3-9
3.2.4	3-Channel Multifunction Option Module .....	3-13
3.2.5	Multidrop Option Module .....	3-17
3.4	Arranging for TI to Install Your Board .....	3-19

---

**Index**

	Figure	Title	Page
<b>Figures</b>	1-1	Communications Processor Board (CCB or CPII) .....	1-4
	2-1	Board Shipping Container .....	2-2
	2-2	Typical Cable Adapter Shipping Container .....	2-3
	3-1	4-Channel Communication Option Typical Configuration .....	3-4
	3-2	8-Channel Asynchronous Communication Option Typical Configuration .....	3-7
	3-3	LAN 802.3 Ethernet Communication Option Typical Configuration .....	3-10
	3-4	LAN 802.3 V.35 Modem Communication Option Typical Configuration .....	3-12
	3-5	CK301 Multifunction Communication Option Typical Configuration .....	3-14
	3-6	CK201 Multifunction Communication Option Typical Configuration .....	3-16
	3-7	Multidrop Option Typical Configuration .....	3-18

	Table	Title	Page
<b>Tables</b>	3-1	Peripheral Devices Available for Connection to the CK401 Option Kit .....	3-5
	3-2	Cables for Connecting the Devices of Table 3-1 .....	3-5
	3-3	Peripheral Devices Available for Connection to the CK801 Option Kit .....	3-8
	3-4	Cables for Connecting the Devices of Table 3-3 .....	3-8
	3-5	Peripheral Devices Available for Connection to the CK1601 Option Kit .....	3-11
	3-6	Cables for Connecting the Devices of Table 3-5 .....	3-11

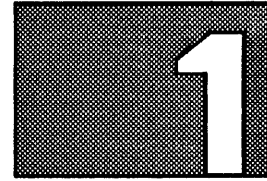

## GENERAL DESCRIPTION

---

### Introduction

**1.1** The System 1500 computer option board family includes two communication processor boards, called the communications carrier board (CCB) and the communication processor II (CPII) board. Either of these boards, when installed in the computer, can support up to two of the following communication option modules, which provide interfaces to a variety of printers, terminals, and communication networks:

- 4-channel EIA-232 asynchronous communication module — This module and its associated connector adapter provide an EIA-232 serial interface that can support video display terminals (VDTs), serial printers, and EIA asynchronous modems. The module (TI part number 2535560-0001) is part of the following kits:
  - Factory-installed CK401 4-channel EIA-232 asynchronous communication kit, TI part number 2542972-0002
  - Field-installable CK401 4-channel EIA-232 asynchronous communication kit, TI part number 2542972-0001
- 8-channel asynchronous communication module — This module and its associated connector adapter provides an EIA-232 serial interface that can support VDTs, serial printers, and EIA asynchronous modems. The module (TI part number 2535570-0001) is part of the following kits:
  - Factory-installed CK801 8-channel asynchronous communication kit, TI part number 2542971-0002
  - Field-installable CK801 8-channel asynchronous communication kit, TI part number 2542971-0001
- CK202 multidrop communication module — This module and its associated connector adapters provide a synchronous interface that can support either a parallel printer and one or more multidrop terminal concentrators (MTCs) or a parallel printer and a V.35 modem. The module (TI part number 2554910-0001) is part of the following kits:
  - Factory-installed CK802 multidrop terminal concentrator starter kit, TI part number 2554929-0002
  - Field-installable CK802 multidrop terminal concentrator kit, TI part number 2554929-0001

<sup>1</sup>Electronic Industries Association.

- Token ring communication module — This module and its associated connector adapter provides an interface to an IEEE2 802.5 token ring local area network (LAN). The module (TI part number 2549655-0001) is part of the field-installable token ring communication kit, TI part number 2549652-0001.
- LAN 802.3 communication module — This module and its associated connector adapters provide an interface to either an Ethernet® LAN or a V.35 modem. The module (TI part number 2535590-0001) is part of the following kits:
  - Factory-installed CK1601 16-channel Ethernet starter kit, 120-volt, TI part number 2542984-0004
  - Field-installable CK1601 16-channel Ethernet starter kit, 120-volt, TI part number 2542984-0001
  - Factory-installed CK1601 16-channel Ethernet starter kit, 220- volt, TI part number 2542984-0002
  - Field-installable CK1601 16-channel Ethernet starter kit, 240-volt, TI part number 2542984-0003
  - Field-installable CK1601 16-channel Ethernet starter kit, 220-volt, TI part number 2542984-0005
- 3-channel multifunction communication module — This module and its associated connector adapters provide interfaces for a parallel printer, an autocal unit, an EIA synchronous modem, and a V.35 modem. The board (TI part number 2535580-0002) is part of the following kits:
  - Factory-installed CK301 multifunction communication kit, TI part number 2542973-0002 (Revision: E)
  - Field-installable CK301 multifunction communication kit, TI part number 2542973-0001 (Revision: E)
  - Factory-installed CK201 multifunction communication kit, TI part number 2535619-0002 (Revision: B)
  - Field-installable CK201 multifunction communication kit, TI part number 2535619-0001 (Revision: B)

---

**CAUTION: The CPII requires the kit revisions to be equal to or greater than those that are noted above in parentheses ().**

---

The CCB and the CPII both provide the core functions of an intelligent peripheral controller and are physically and functionally very similar, as shown by the block diagram of Figure 1-1.

<sup>2</sup>Institute of Electrical and Electronic Engineers

Ethernet is a registered trademark of Xerox Corporation.

Each of these boards provides two identical sets of port connectors (P4 and P6 for port 0 and P5 and P7 for port 1), each of which can accommodate any of the previously described communication option modules. Connectors P2 and P3, respectively, provide interfaces (via the backplane) between ports 0 and 1 and their associated connector adapters. Connector P1 provides an interface between the CCB or CPII and the NuBus™.

Three light-emitting diodes (LEDs) are located at the front bottom of the board when it is installed in the computer. The inner front enclosure door provides viewing slots near the bottom of the door. To view the LEDs while the system is running, open the front outer enclosure door and look through the appropriate viewing slot. The top Amber LED indicates a port 0 failure, the middle Amber LED indicates a port 1 failure, and the bottom Red LED indicates a board failure. All three LEDs remain on during self-test execution.

NuBus is a trademark of Texas Instruments Incorporated.

Figure 1-1 Communication Processor Board (CCB or CPII)

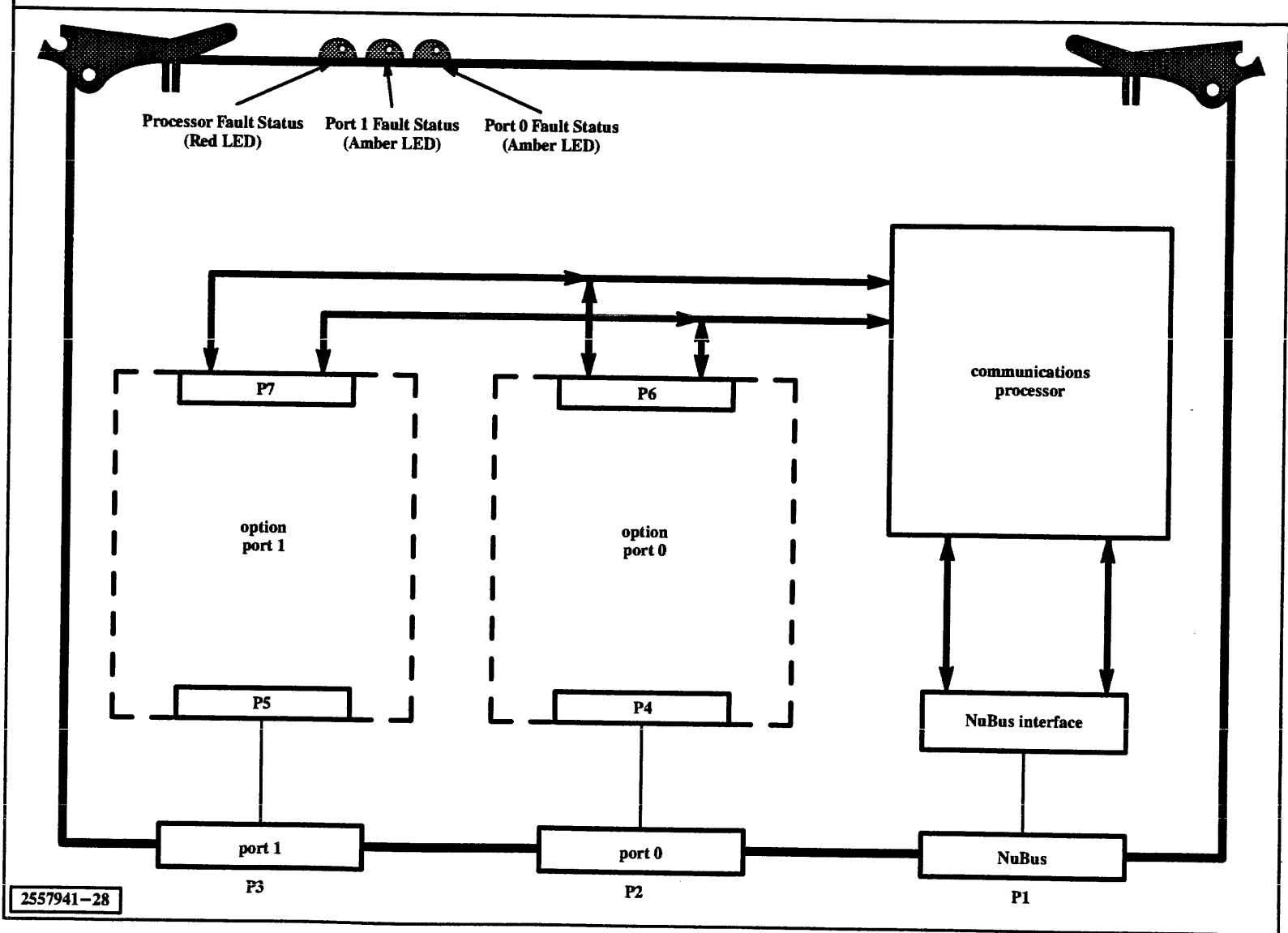



---

## Communications Carrier Board

**1.2** The CCB, TI part number 2535555-0001, uses the Motorola 68010 16-bit microprocessor operating at 10 megahertz and has 512K bytes of onboard dynamic random-access memory (DRAM). The board is capable of both slave operations and master operations on the NuBus and uses static random-access memory (SRAM) mapping to gain control of the bus. Other key features of the CCB are as follows:

- Provides 8K bytes of 16-bit SRAM — This memory is dedicated to the 68010 microprocessor for use as stacks, control words, and other time-critical code.
- Provides 32K bytes of electrically programmable read-only memory (EPROM) — This memory stores the primitive code interpreter, the self-test code, fixed parameters, and special-purpose code.
- Provides 4K-bytes configuration read-only memory (ROM) — This memory contains the flag and configuration registers for system-required NuBus, self-test, and system test boot master (STBM) support.
- Contains an MC68230 programmable interval/timer (PI/T) — This integrated circuit provides software controlled timing for onboard status handling, flag register source, ports 0 and 1 reset and channel active functions, and most other board functions.
- Contains an LS15420 gate-array Interrupt controller chip (ICC) — This custom integrated circuit provides interrupt assertion and NuBus event vector generation.

The CCB is part of the following kits:

- Factory-installed communication processor kit with CPU and 512K byte-RAM, TI part number 2542991-0002
- Field-installable communication processor kit with CPU and 512K byte-RAM, TI part number 2542991-0001

---

## Communication Processor II Board

**1.3** The CPII, TI part number 2567360-0001, uses a Motorola 68020 32-bit microprocessor operating at 30 megahertz and has 2 megabytes of onboard dynamic random-access memory (DRAM). The board is capable of both slave operations and master operations on the NuBus and uses direct mapping to gain control of the bus. Thus, the CPII is considerably faster than the first generation CCB. Other key features of the CPII are as follows:

- Provides 512K bytes of 32-bit SRAM — This memory is dedicated to the 68020 microprocessor for use as stacks, control words, and other time-critical code.
- Provides 128K bytes of 32-bit EPROM — This memory stores the primitive code interpreter, the self-test code, fixed parameters, and special-purpose code.

Many of the features that were formerly available as individual integrated circuits or discrete logic on the CCB have been integrated into a single application-specific integrated circuit (ASIC) for the CPII. The CPII ASIC provides the following key features:

- NuBus configuration register and flag register for system-required NuBus, self-test, and STBM support

- Event/interrupt logic for interrupt assertion and NuBus event vector generation
- 16-bit interval timer, 8-bit programmable timer, and 32-bit timestamp timer to handle the functions that were formerly handled by the MC68230 PI/T on the CCB
- Various control registers and debug/trace registers

The CPII is part of the following kits:

- Factory-installed CPII kit, TI part number 2567401-0002
- Field-installable CPII kit, TI part number 2567401-0001

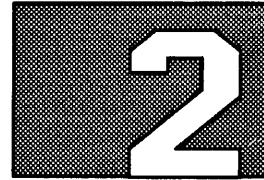

## UNPACKING THE BOARD

---

### Unpacking the Board and Associated Cable Adapters

**2.1** System owners who install their own system boards and associated cable adapters should perform the following steps to unpack the equipment:

1. Visually inspect the shipping container for damage. If the inspection reveals damage to the shipping container, contact the carrier agent for instructions on filing a claim. The carrier, not Texas Instruments, is responsible for damage during shipment. Resolve all problems relating to shipping damage before proceeding with the installation.
2. Note on the delivery receipt any problems that you discover.
3. Be sure that the driver has signed the delivery receipt.
4. Obtain a knife for cutting the sealing tape that secures the board and the cable adapter packing containers.

---

**CAUTION:** The board contains static-sensitive electronic components. To avoid damage to these components, ensure that you are well grounded before handling the board.

The recommended method is to use a static-control system consisting of a static-control floor or table mat and a static-control wrist strap. These are commercially available. If you do not have a static-control system, you can discharge any accumulated static charge by touching a grounded object prior to handling the board.

Before storing or transporting the board, return it to its protective package.

---

---

**WARNING:** Some of the system boards have a lithium battery that will discharge and possibly explode if the positive and negative terminals of the battery are shorted together. DO NOT place the system board on a conductive surface, such as the outside surfaces of the static-protective shipping bag, as this can discharge the battery. The outside surface of all static-protective shipping bags are conductive.

---

5. As you unpack the board (Figure 2-1) and the associated cable adapters (Figure 2-2), inspect the equipment for shipping damage. If the inspection reveals damage that you feel is significant, stop the unpacking procedure and contact the carrier agent. After the carrier agent inspects the damage, contact a Texas Instruments Field Service office. Save all the packing material for future use whenever possible.

Figure 2-1

Board Shipping Container

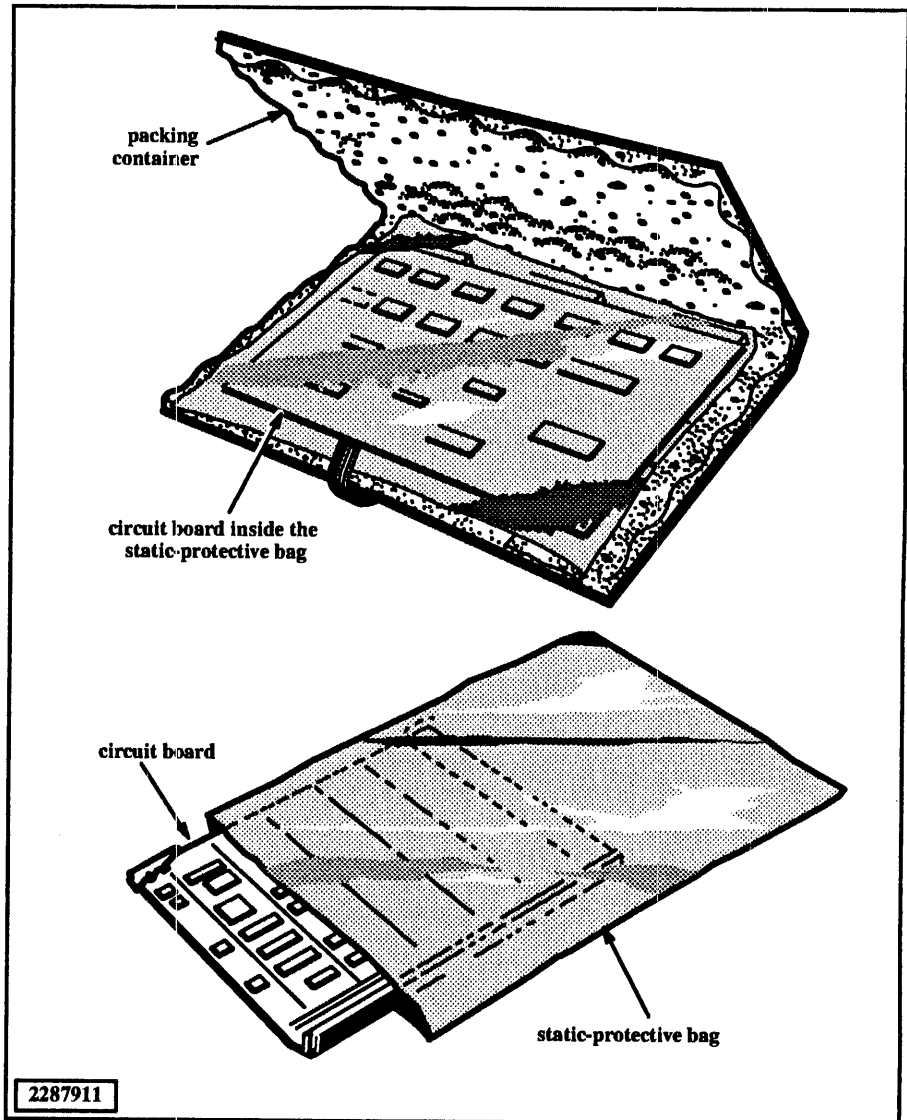
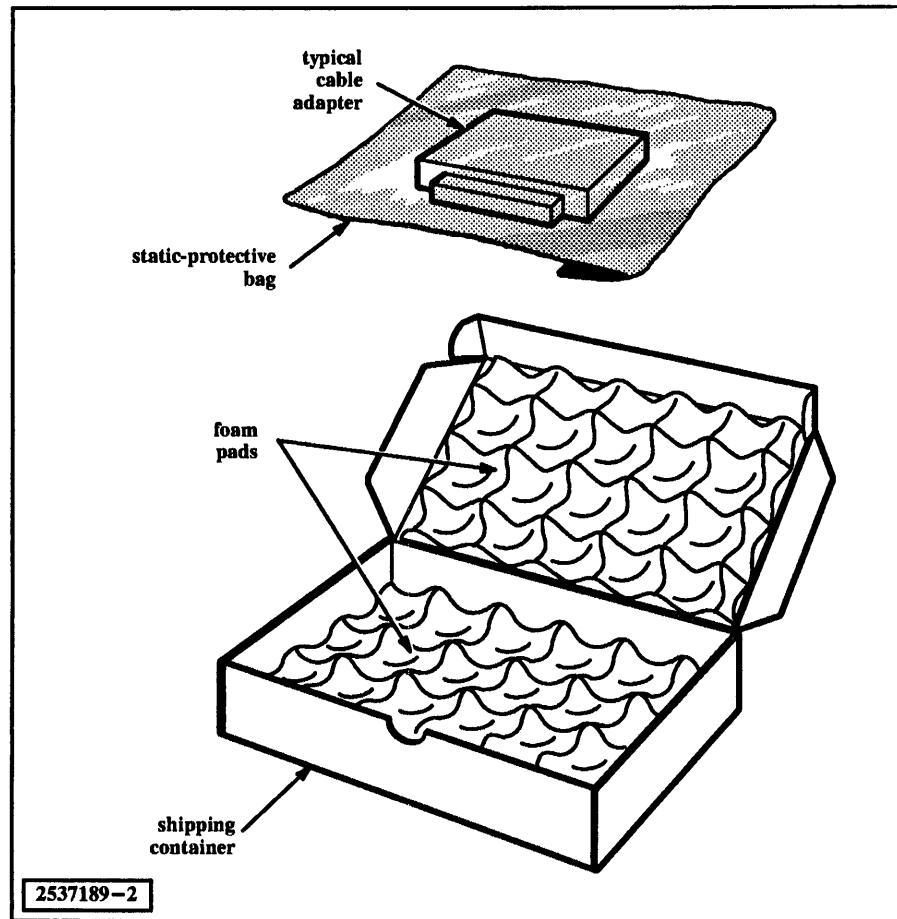
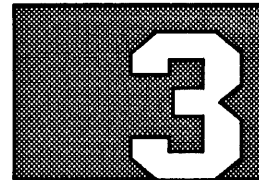

Figure 2-2

Typical Cable Adapter Shipping Container



# COMMUNICATION PROCESSOR INSTALLATION



---

## Introduction

**3.1** If your original purchase order specifies the communications carrier board (CCB) or the communication processor II (CPII) board, your computer is shipped from the factory with the board installed and configured with the option modules and connector adapters specified by your order. If you decide to add one of the boards at a later date, you must either install the board yourself or arrange for Texas Instruments to install it for you.

---

**WARNING:** To eliminate the possibility of electrical shock during option or upgrade installation, you must isolate the system enclosure from all potential energy sources. To isolate the system enclosure:

- 1.** Power off the system enclosure and all peripherals.
  - 2.** Disconnect the power cable from the wall outlet of all local peripherals connected to the system enclosure.
  - 3.** Disconnect all interface cables between the system enclosure and all remote peripherals.
  - 4.** Unplug the system enclosure power cable from the wall outlet.
- 

---

**CAUTION:** All boards, options, adapters, and peripherals contain components that are sensitive to static electricity. When handling any of these items, protect against static electricity by using wrist grounding straps, grounded working mats, and antistatic bags for moving or storing the items.

---

---

## Installing the Board and its Associated Options

**3.2** The general procedure for installing the CCB or CPII includes installing one or more option modules on the board, inserting the board into the system enclosure, and installing a connector adapter on the system backplane. After these items have been installed, various peripheral devices can be connected via the connector adapters.

---

**NOTE:** The method of gaining access to the system backplane varies from one type of system enclosure to another. The *Computer Enclosure Installation and Operation* manual, TI part number 2557942-0001 provides instructions for accessing the system backplane and inserting boards in the system enclosures.

---

Each of the option modules described in Section 1 has one or more associated connector adapters that provide interfaces to various peripheral devices. You can install any of these option modules and their associated adapters in either port 0 or port 1 of the CCB or the CPII board. Use the following steps to install an option module on the board and its associated connector adapters on the system enclosure backplane:

1. Place the CCB or CPII board on a grounded working mat, and remove the option module from its antistatic shipping bag.
2. Attach the insulation material to the back of the option module with the plastic clips provided.
3. Carefully align the option module connectors with the desired port connectors on the CCB or CPII board.
4. Press the option module connectors into the CCB or CPII board port connectors and then install the CCB or CPII board in the system enclosure.
5. Locate the backplane slot that contains the CCB or CPII with the newly installed option board.

---

**CAUTION: Each adapter board is designed for a specific option board. Incorrect pairing of an adapter board and an option board can cause component damage.**

---

6. Orient the connector adapter at the rear of the system enclosure so that its 96-pin connector faces the backplane.
7. Slide the adapter between the mounting rails and into the backplane connector.
8. Some connector adapters have more than one interface cable connector. The interface cable(s) you use depends upon the device you are installing. Insert the angled interface cable connector(s) into the assigned adapter connector(s).
9. Route the interface cable(s) out of the bottom rear of the enclosure.
10. Mark the peripheral end of each interface cable with the assigned channel number so that the correct cable can be connected to the correct peripheral. To ensure that you connect peripherals to appropriate channels, contact your system administrator for channel assignments.

The following paragraphs provide information about the option module kits and how to install them. The following manuals contain additional instructions for installing peripheral equipment associated with the CCB or CPII board and their associated option modules:

- *Terminal Concentrator Installation and Operation* manual, TI part number 2557938-0001
- *Terminal/Printer Information* manual, TI part number 2557939-0001

---

**4-Channel  
Asynchronous  
Option Module**

**3.2.1** Figure 3-1 shows a typical configuration of peripheral devices connected to your computer via a CK401 4-channel EIA-232 asynchronous communication kit. The kit is available in the factory-installed version, TI part number 2542972-0002 or the field-installable version, TI part number 2542972-0001. Both versions contain the following items:

- 4-channel EIA-232 asynchronous communication module, TI part number 2535560-0001
- 4-channel connector adapter TI part number 2535565-0001

The 4-channel EIA-232 asynchronous communication module extends the functions of the CCB or CPII to provide interfaces to various terminals, printers, and modems. The 4-channel connector adapter connects to the module via the system enclosure backplane and provides four 18-pin, male, D-type connectors, each of which can accommodate any of the devices listed in Table 3-1. Table 3-2 lists the cables that are available for connecting these devices to the connector adapter.

To test the 4-channel option board and its adapter, install the 18-pin loopback connector, TI part number 2538980-0001 (shown in Figure 3-1), to the adapter connectors one at a time, and run the loopback test. To test a peripheral cable, attach the 25-pin loopback connector, TI part number 2532884-0001, to the peripheral end of the cable, and run the loopback test. If four loopback connectors are used, all channels can be tested at one time.



Figure 3-1 4-Channel Communication Option Typical Configuration

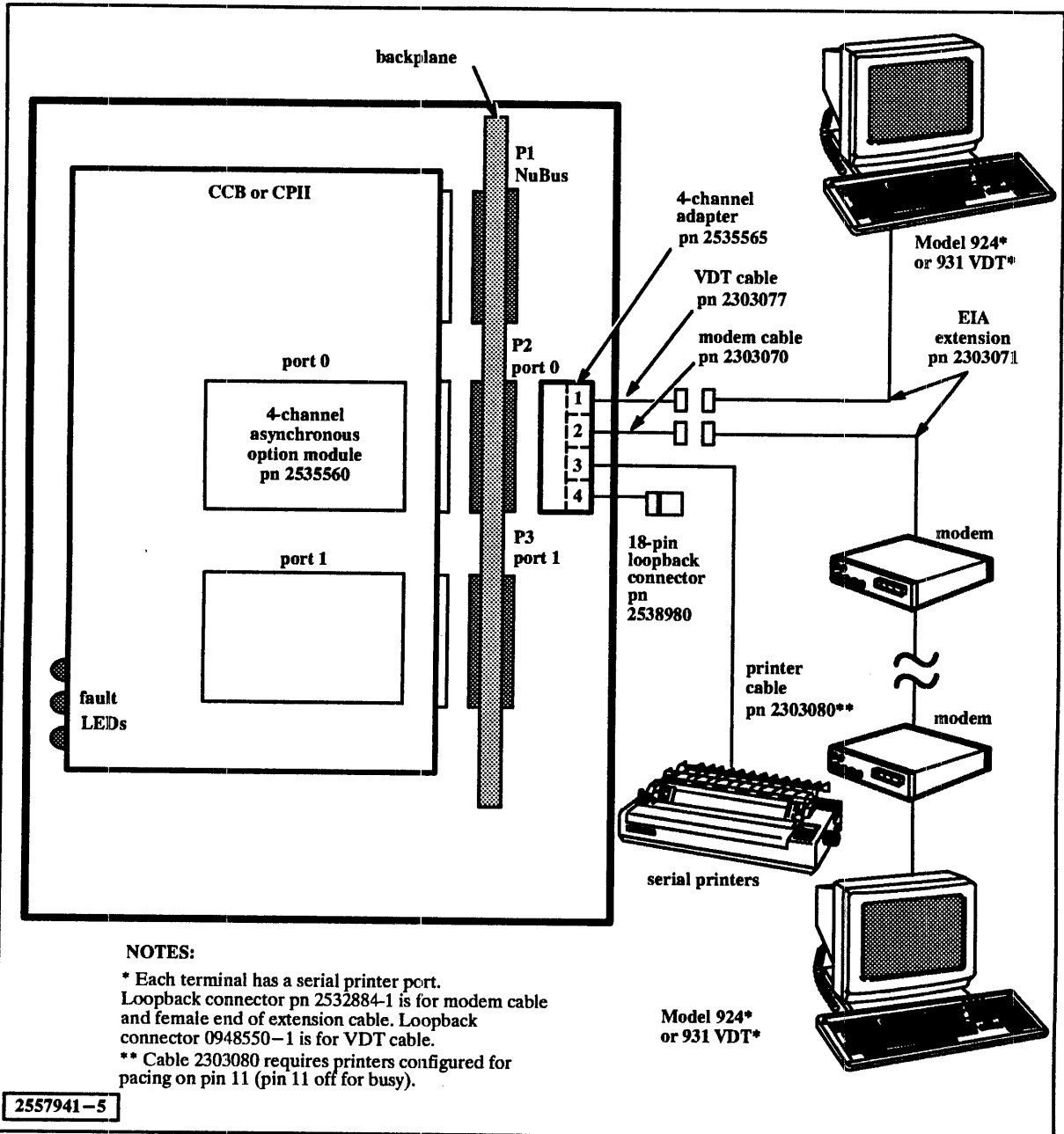

**Table 3-1 Peripheral Devices Available for Connection to the CK401 Option Kit**

Peripheral Device	Cables (See Table 3-2)	
	Primary	Extension
EIA asynchronous modem	B or C	None
<i>Terminals:</i>		
Model 924 communication port	F	D or E
Model 928 D-type communication port	F and H	None
Model 931 communication port	F	D or E
Model 945 workstation	B or C	None
Model 955 workstation	B or C	None
<i>Dot-Matrix Impact Printers:</i>		
Model 810	G	D or E
Model 830 with serial option (X-on/X-off protocol)	F	D or E
Model 830 with serial option (ready/busy protocol)	G	D or E
Model 835 with serial option (X-on/X-off protocol)	F	D or E
Model 835 with serial option (ready/busy protocol)	G	D or E
Model 850 (serial mode)	G and A	D or E
Model 850XL (serial mode)	G and A	D or E
Model 855 (serial mode, X-on/X-off protocol)	A and F	D or E
Model 855 (serial mode, ready/busy protocol)	G and A	D or E
Model 857 (serial mode, X-on/X-off protocol)	A and F	D or E
Model 857 (serial mode, ready/busy protocol)	G and A	D or E
Model 860XL (serial mode)	G and A	D or E
Model 865 (serial mode, X-on/X-off protocol)	A and F	D or E
Model 865 (serial mode, ready/busy protocol)	G and A	D or E
Model 875 with serial option F		D or E
Model 877 with serial option F		D or E
Model 880 (serial mode, X-on/X-off protocol)	F	D or E
Model 880 (serial mode, ready/busy protocol)	G	D or E
Model 885 (serial mode, X-on/X-off protocol)	F	D or E
Model 885 (serial mode, ready/busy protocol)	G	D or E
<i>Laser Printers:</i>		
microLaser with serial option F		D or E
Model 2015 (serial mode)	F	D or E
Model 2106 (serial mode)	F	D or E
Model 2108 (serial mode)	F	D or E
Model 2115 (serial mode)	F	D or E

**Table 3-2 Cables for Connecting the Devices of Table 3-1**

Item	TI Part Number	Length (Feet)	Connector 1	Connector 2
A	2222477-0002	0.5	36-pin male (Centronics)	25-pin female (D-type)
B	2303070-0002	30	18-pin female (MODU™ -type)	25-pin male (D-type)
C	2303070-0003	10	18-pin female (MODU-type)	25-pin male (D-type)
D	2303071-0002	49	25-pin female (D-type)	25-pin male (D-type)
E	2303071-0004	200	25-pin female (D-type)	25-pin male (D-type)
F	2303077-0001	30	18-pin female (MODU-type)	25-pin male (D-type)
G	2303080-0001	30	18-pin female (MODU-type)	25-pin male (D-type)
H	2544288-0001	0.5	25-pin female (D-type)	25-pin male (D-type)

MODU is a trademark of AMP Incorporated.

**8-Channel  
Asynchronous  
Option Module**

**3.2.2** Figure 3-2 shows a typical configuration of peripheral devices connected to your computer via a CK801 8-channel asynchronous communication kit. The kit is available in the factory-installed version, TI part number 2542971-0002 or the field-installable version, TI part number 2542971-0001. Both versions contain the following items:

- 8-channel asynchronous communication module, TI part number 2535570-0001 — extends the functions of the CCB or CPII to provide interfaces to various terminals, printers, and modems.
- 8-channel connector adapter, TI part number 2535575-0001 — connects to the 8-channel asynchronous communication module via the system enclosure backplane and provides a 50-pin male connector for the 8-channel cable assembly.
- 8-channel cable assembly, TI part number 2537332-0002 — connects between the 8-channel connector adapter and the 8-channel connector strip. The cable assembly is 13.1 feet long and has a 50-pin, female, MODU-type connector on one end for connection to the 8-channel connector adapter; it has a 50-pin, female, D-type connector on the other end for connection to the 8-channel connector strip.
- 8-channel connector strip, TI part number 2537333-0001 — connects to the 8-channel cable assembly and provides eight 25-pin, female, D-type connectors, each of which can accept a printer, terminal, or modem cable.

The 8-channel cable assembly has a bail lock on the connector strip end and the 50-pin connector of the connector strip has a bail latch. These provide a means of securing the connectors to each other. Table 3-3 lists the devices that can be connected to the 8-channel asynchronous module via the 8-channel connector strip and the 8-channel cable assembly. Table 3-4 lists the cables that are available for connecting these devices.

To test the 8-channel option module, interface cable, and peripheral cables, use the 25-pin loopback connector, TI part number 2532884-0001, and run the loopback test for this option module.

Figure 3-2 8-Channel Asynchronous Communication Option Typical Configuration

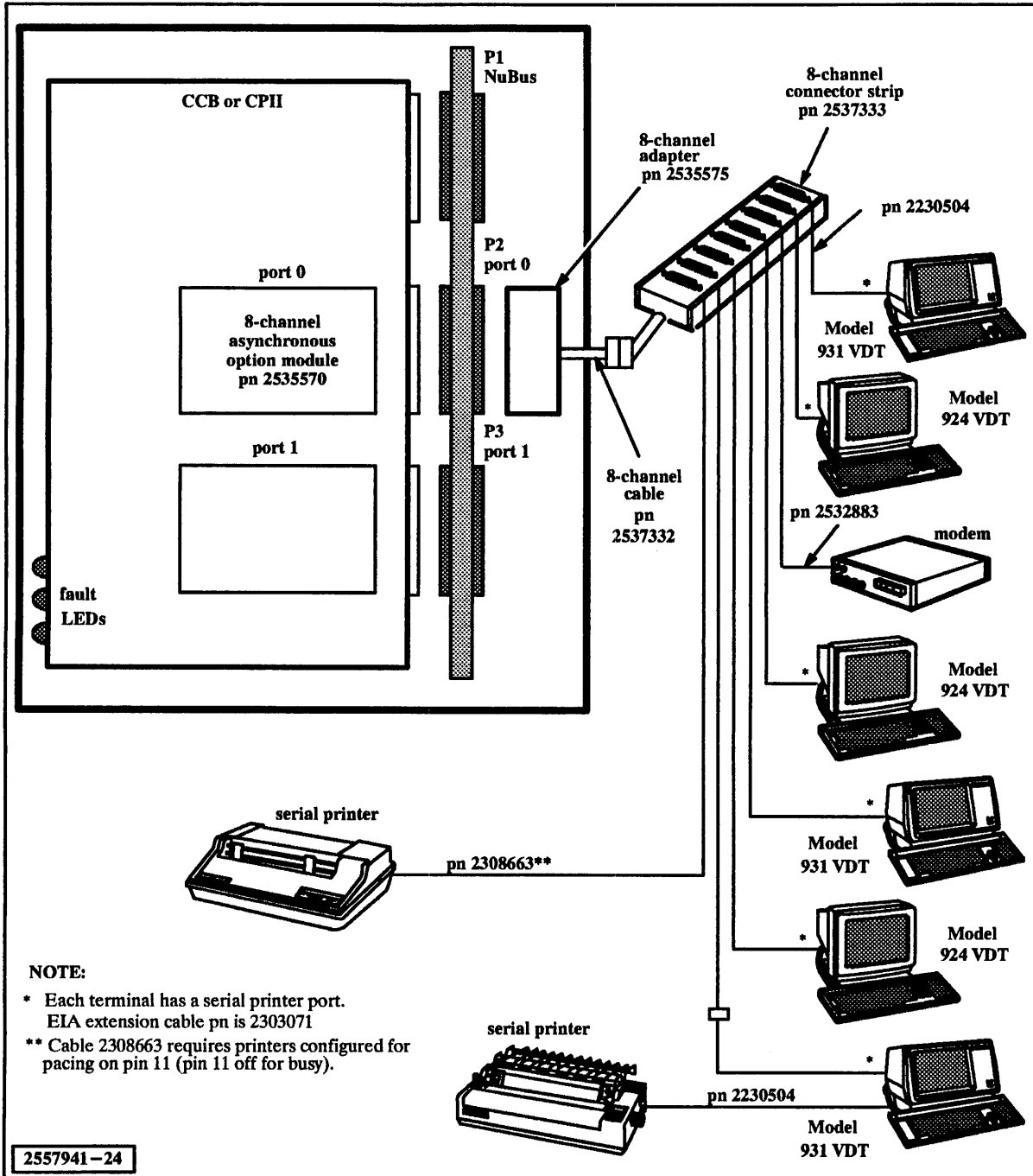

**Table 3-3 Peripheral Devices Available for Connection to the CK801 Option Kit**

Peripheral Device	Cables (See Table 3-4)	
	Primary	Extension
EIA asynchronous modem	H	None
<i>Terminals:</i>		
Model 924 communication port	B, C, or D	E or F
Model 928 D-type communication port	I and B, C, or D	None
Model 931 communication port	B, C, or D	E or F
Model 945 workstation	I and B, C, or D	E or F
Model 955 workstation	I and B, C, or D	E or F
<i>Dot-Matrix Impact Printers:</i>		
Model 810	G	E or F
Model 830 with serial option	B, C, or D	E or F
Model 835 with serial option	B, C, or D	E or F
Model 850 (serial mode)	G and A	E or F
Model 850XL (serial mode)	G and A	E or F
Model 855 (serial mode)	A and B, C, or D	E or F
Model 857 (serial mode)	A and B, C, or D	E or F
Model 860XL (serial mode)	G and A	E or F
Model 865 (serial mode)	A and B, C, or D	E or F
Model 875 with serial option	B, C, or D	E or F
Model 877 with serial option	B, C, or D	E or F
Model 880 (serial mode)	B, C, or D	E or F
Model 885 (serial mode)	B, C, or D	E or F
Model 8920 (serial mode)	B, C, or D	E or F
Model 8930 (serial mode)	B, C, or D	E or F
<i>Laser Printers:</i>		
microLaser with serial option	B, C, or D	E or F
Model 2015 (serial mode)	B, C, or D	E or F
Model 2106 (serial mode)	B, C, or D	E or F
Model 2108 (serial mode)	B, C, or D	E or F
Model 2115 (serial mode)	B, C, or D	E or F

**Table 3-4 Cables for Connecting the Devices of Table 3-3**

Item	TI Part Number	Length (Feet)	Connector 1	Connector 2
A	2222477-0002	0.5	36-pin male (Centronics)	25-pin female (D-type)
B	2230504-0001	13	25-pin male (D-type)	25-pin male (D-type)
C	2230504-0002	26	25-pin male (D-type)	25-pin male (D-type)
D	2230504-0003	49	25-pin male (D-type)	25-pin male (D-type)
E	2303071-0002	49	25-pin female (D-type)	25-pin male (D-type)
F	2303071-0004	200	25-pin female (D-type)	25-pin male (D-type)
G	2308663-0001	13	25-pin male (D-type)	25-pin male (D-type)
H	2532883-0001	10	25-pin male (D-type)	25-pin male (D-type)
I	2544288-0001	0.5	25-pin female (D-type)	25-pin female (D-type)

**LAN 802.3  
Option Module**

**3.2.3** The local area network (LAN) 802.3 option module can support either one LAN 802.3 Ethernet channel or one V.35 modem channel, depending upon which connector adapter is used. The available connector adapters are the Ethernet adapter, TI part number 2535600-0001, and the V.35 modem adapter 2535605-0001, each of which contains protocol-specific electronics.

Figure 3-3 shows a LAN 802.3 option module mounted on a CCB or CPIO at port 0 with connections via an Ethernet to a network terminal concentrator (NTC). The module is part of the CK1601 16-channel Ethernet starter kit, which is available in the following versions:

- Factory-installed CK1601 16-channel Ethernet starter kit, 120-volt, TI part number 2542984-0004
- Factory-installed CK1601 16-channel Ethernet starter kit, 220-volt, TI part number 2542984-0002
- Field-installable CK1601 16-channel Ethernet starter kit, 120-volt, TI part number 2542984-0001
- Field-installable CK1601 16-channel Ethernet starter kit, 240-volt, TI part number 2542984-0003
- Field-installable CK1601 16-channel Ethernet starter kit, 220-volt, TI part number 2542984-0005

All versions of the CK1601 Ethernet starter kit contain the following components:

- LAN 802.3 communication module, TI part number 2535590-0001 — extends the functions of the CCB or CPIO to support an Ethernet 802.3 LAN.
- Two Ethernet connector adapters, TI part number 2535600-0001 — One of these adapters connects to the LAN 802.3 communication module via the system enclosure backplane and the other connects to the NTC to provide connections from these devices to the Ethernet LAN.
- Two Ethernet transceiver kits, TI part number 2244733-0001 — Each of these kits contains an Ethernet Transceiver, TI part number 2236673-0002. One of these transceivers provides communication between the Ethernet LAN and the LAN 802.3 communication module; the other provides communication between the Ethernet LAN and the NTC.
- Two Ethernet transceiver cables, TI part number 2239129-0001 — These cables connect the system enclosure backplane and NTC Ethernet connector adapters to their respective Ethernet transceivers. Each of these cables is 32.8 feet (10 meters) long and has an 18-pin, female, MODU-type connector on one end and a 15-pin, female, D-type connector on the other end. The MODU-type connector attaches to the Ethernet connector adapter and the D-type connector attaches to the transceiver.
- Thin Ethernet cable, TI part number 2239703-0003 — This cable is 98.4 feet (30 meters) long and has a female BNC connector at each end. The cable serves as a link between two Ethernet transceivers in a LAN.

- Thin Ethernet terminator kit, TI part number 2239130-0001 — This kit contains one grounded terminator and one ungrounded terminator for connection to the ends of an Ethernet segment. Each of these terminators contains a female BNC connector.
- NTC, TI part number 2537305-0001 — This assembly serves as an interface between the Ethernet and a maximum of 16 of the devices listed in Table 3-5. Table 3-6 lists the cables that are available to connect these devices to the NTC.

Figure 3-3 LAN 802.3 Ethernet Communication Option Typical Configuration

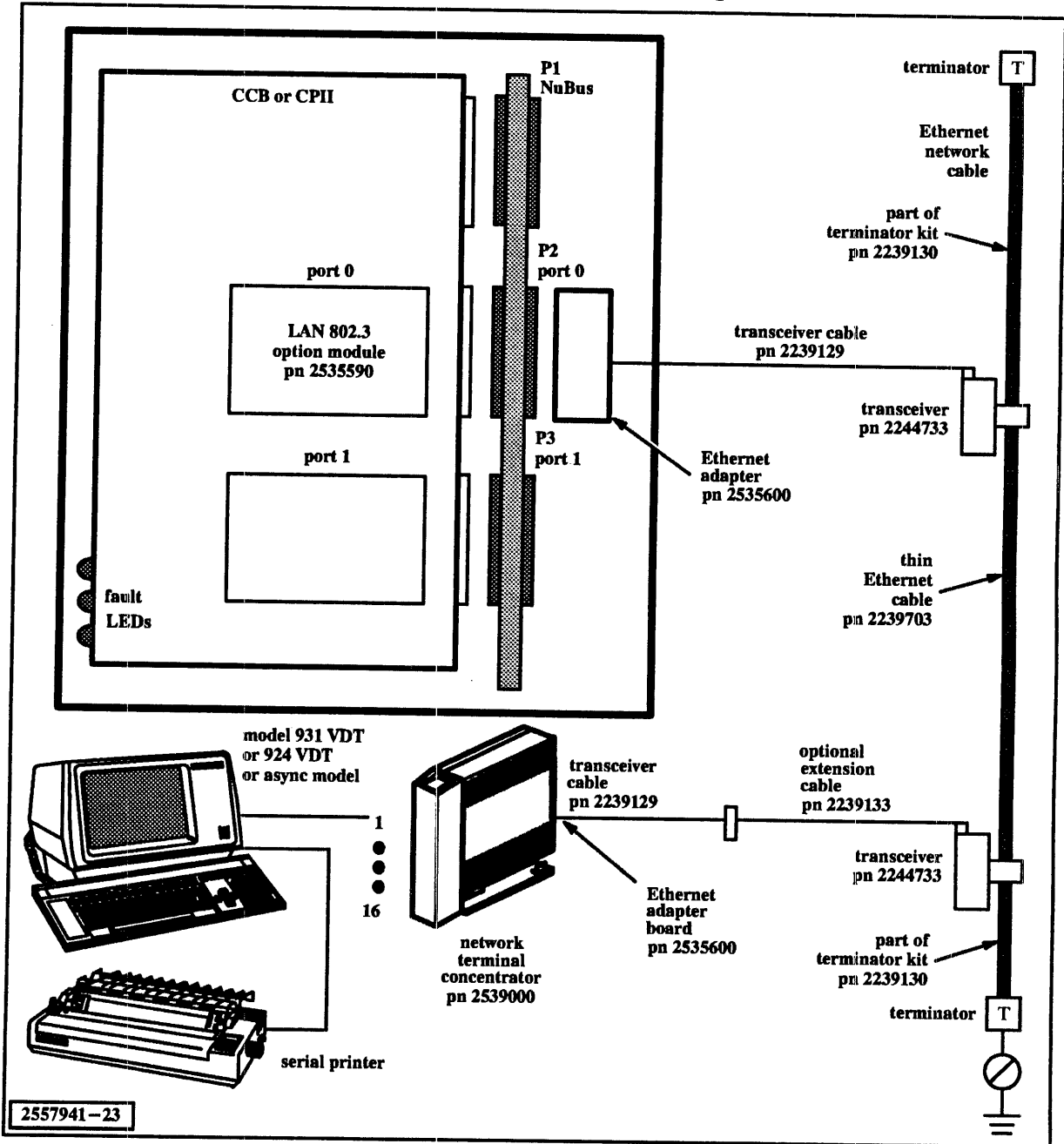

**Table 3-5 Peripheral Devices Available for Connection to the CK1601 Option Kit**

Peripheral Device	Cables (See Table 3-6)	
	Primary	Extension
EIA asynchronous modem	H	None
<i>Terminals:</i>		
Model 924 communication port	B, C, or D	E or F
Model 928 D-type communication port	I and B, C, or D	None
Model 931 communication port	B, C, or D	E or F
Model 945 workstation	I and B, C, or D	E or F
Model 955 workstation	I and B, C, or D	E or F
<i>Dot-Matrix Impact Printers:</i>		
Model 810	G	E or F
Model 830 with serial option	B, C, or D	E or F
Model 835 with serial option	B, C, or D	E or F
Model 850 (serial mode)	G and A	E or F
Model 850XL (serial mode)	G and A	E or F
Model 855 (serial mode)	A and B, C, or D	E or F
Model 857 (serial mode)	A and B, C, or D	E or F
Model 860XL (serial mode)	G and A	E or F
Model 865 (serial mode)	A and B, C, or D	E or F
Model 875 with serial option	B, C, or D	E or F
Model 877 with serial option	B, C, or D	E or F
Model 880 (serial mode)	B, C, or D	E or F
Model 885 (serial mode)	B, C, or D	E or F
Model 8920 (serial mode)	B, C, or D	E or F
Model 8930 (serial mode)	B, C, or D	E or F
<i>Laser Printers:</i>		
microLaser with serial option	B, C, or D	E or F
Model 2015 (serial mode)	B, C, or D	E or F
Model 2106 (serial mode)	B, C, or D	E or F
Model 2108 (serial mode)	B, C, or D	E or F
Model 2115 (serial mode)	B, C, or D	E or F

**Table 3-6 Cables for Connecting the Devices of Table 3-5**

Item	TI Part Number	Length (Feet)	Connector 1	Connector 2
A	2222477-0002	0.5	36-pin male (Centronics)	25-pin female (D-type)
B	2230504-0001	13	25-pin male (D-type)	25-pin male (D-type)
C	2230504-0002	26	25-pin male (D-type)	25-pin male (D-type)
D	2230504-0003	49	25-pin male (D-type)	25-pin male (D-type)
E	2303071-0002	49	25-pin female (D-type)	25-pin male (D-type)
F	2303071-0004	200	25-pin female (D-type)	25-pin male (D-type)
G	2308663-0001	13	25-pin male (D-type)	25-pin male (D-type)
H	2532883-0001	10	25-pin male (D-type)	25-pin male (D-type)
I	2544288-0001	0.5	25-pin female (D-type)	25-pin female (D-type)



Figure 3-4 shows the LAN 802.3 communication module connected via two V.35 modems and a leased telephone line to a remote NTC. The remote NTC can then support any of the devices listed in Table 3-5. This configuration provides a means of connecting peripheral devices at locations outside the local vicinity. The V.35 adapter kit, TI part number 2535617-0001, contains the following components:

- V.35 modem connector adapter, TI part number 2535605-0001 — provides an interface for the local V.35 modem.
- V.35 modem cable, TI part number 2537301-0001 — This 12-foot (3.7-meter) cable has an 18-pin, female, MODU-type connector on one end for connection to the V.35 adapter and a 34-pin, male, M-series connector on the other end for connection to the V.35 modem.

Figure 3-4 LAN 802.3 V.35 Modem Communication Option Typical Configuration

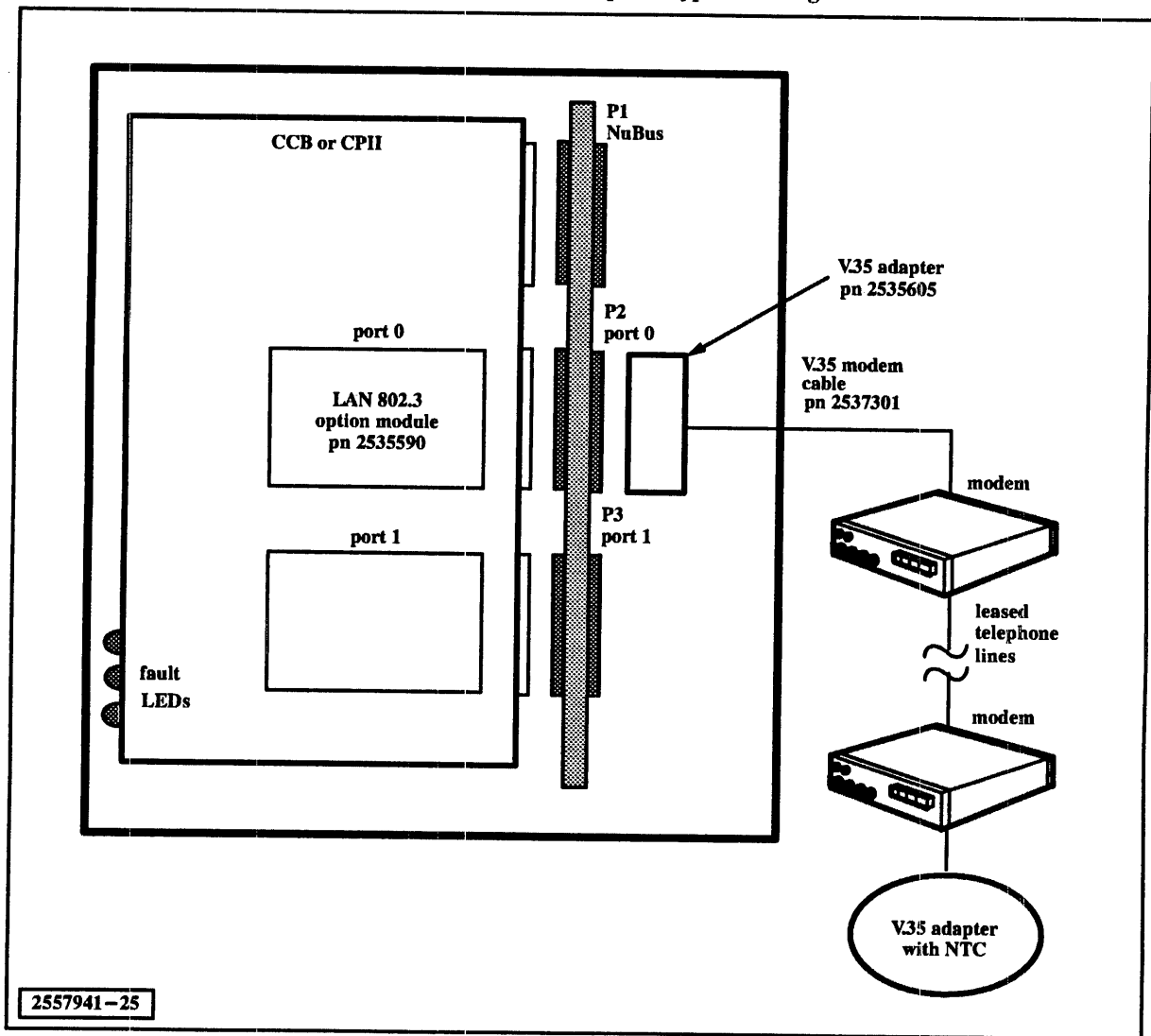

---

**3-Channel  
Multifunction  
Option Module**

**3.2.4** The 3-channel multifunction option module can support either a parallel printer, an EIA-232 asynchronous modem, and an autocal unit, or a parallel printer and a V.35 synchronous modem, depending upon which connector adapter is used.

Figure 3-5 shows a typical configuration of devices connected to the CK301 multifunction communication option. The CK301 multifunction option kit, TI part number 2542973-0001 (field-installable, revision: E) or 2542973-0002 (factory-installed, revision: B), contains the following components:

- 3-channel multifunction option module, TI part number 2535580-0002 — extends the functions of the CCB or CPII to provide interfaces to a parallel printer, an RS-366 autocal unit, or an EIA-232 asynchronous modem. The option module can support any of the devices listed in table 3-7.
- 3-channel multifunction connector adapter, TI part number 2535585-0001 — connects to the multifunction option module via the system enclosure backplane and provides connectors for the parallel printer cable, the autocal unit cable, and the EIA-232 modem cable.

Figure 3-5 CK301 Multifunction Communication Option Typical Configuration

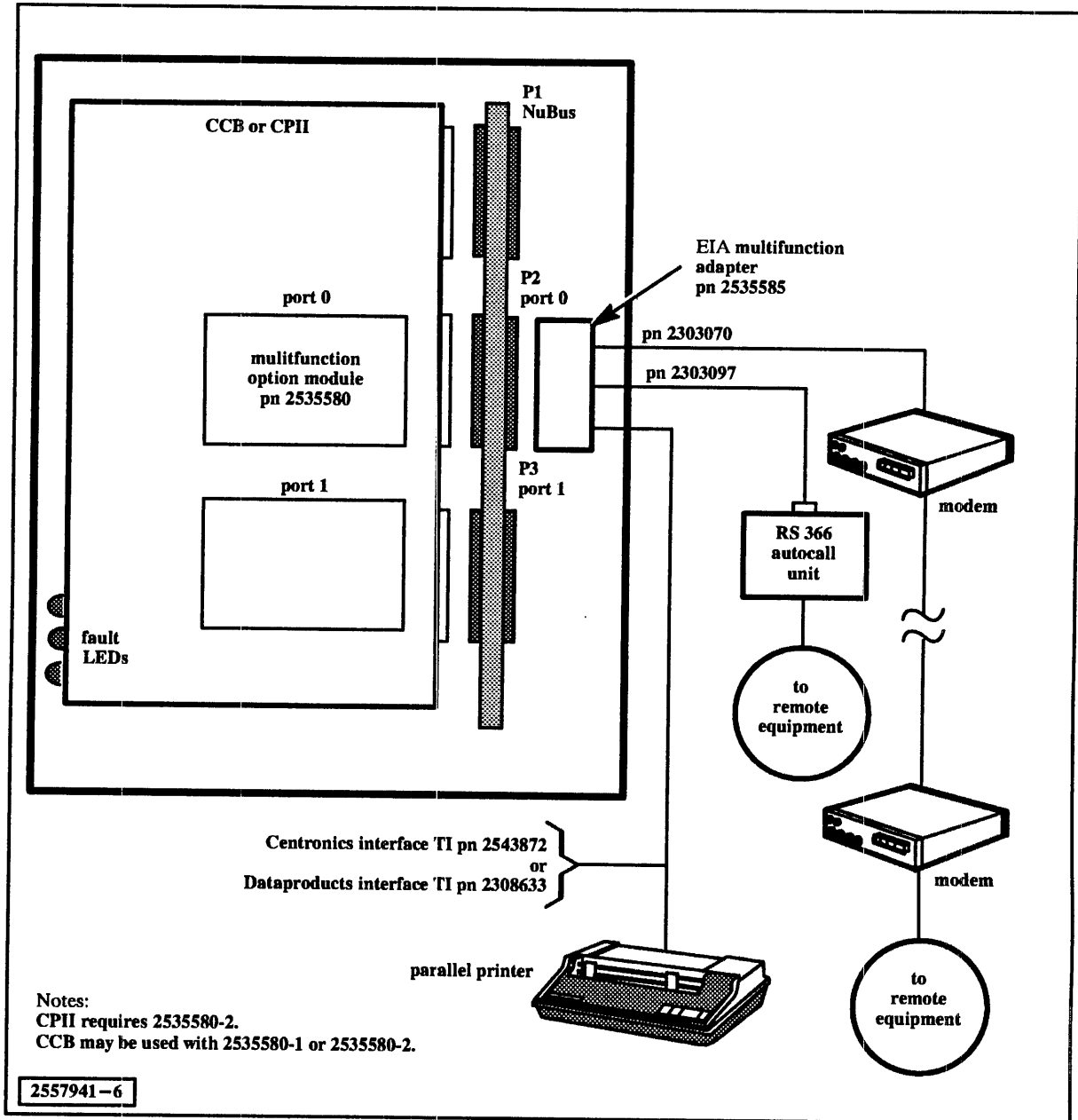

**Table 3-7 Peripheral Devices Available for Connection to the CK301 Option Kit**

Peripheral Device	Cables (See Table 3-8)	
	Primary	Extension
<i>Dot-Matrix Impact Printers:</i>		
Model 810 with parallel option	D	None
Model 830	D	None
Model 835	D	None
Model 875	D	None
Model 877	D	None
Model 880 (parallel mode)	D	None
Model 885 (parallel mode)	D	None
Model 8920 (parallel mode)	D	None
Model 8930 (parallel mode)	D	None
<i>Laser Printers:</i>		
microLaser	D	None
Model 2015 (parallel mode)	D	None
Model 2106 (parallel mode)	D	None
Model 2108 (parallel mode)	D	None
Model 2115 (parallel mode)	D	None
<i>Miscellaneous Devices:</i>		
EIA asynchronous modem	A or B	None
RS-366 autocal unit	C	None

**Table 3-8 Cables for Connecting the Devices of Table 3-7**

Item	TI Part Number	Length (Feet)	Connector 1	Connector 2
A	2303070-0002	30	18-pin female (MODU-type)	25-pin male (D-type)
B	2303070-0003	10	18-pin female (MODU-type)	25-pin male (D-type)
C	2303097-0001	30	18-pin female (MODU-type)	25-pin male (D-type)
D	2543872-0002	49	40-pin female (MODU-type)	36-pin male Centronics

Figure 3-6 shows the 3-channel multifunction communication module connected via two V.35 modems and a leased telephone line to a remote location. This configuration provides a means of connecting peripheral devices at locations outside the local vicinity and can also support any of the printers listed in Table 3-7. The CK201 multifunction communication kit, TI part number 2535619-0001 (field-installable) or 2535619-0002 (factory-installed), contains the following components:

- 3-channel multifunction communication module, TI part number 2535590-0001 — extends the functions of the CCB or CPII to provide interfaces to the parallel printer and the local V.35 modem.
- V.35 modem connector adapter, TI part number 2535605-0001 — provides an interface for the local V.35 modem.

- V.35 modem cable, TI part number 2537301-0001 — This 12-foot (3.7-meter) cable has an 18-pin, female, MODU-type connector on one end for connection to the V.35 adapter and a 34-pin, male, M-series connector on the other end for connection to the V.35 modem.

Figure 3-6 CK201 Multifunction Communication Option Typical Configuration

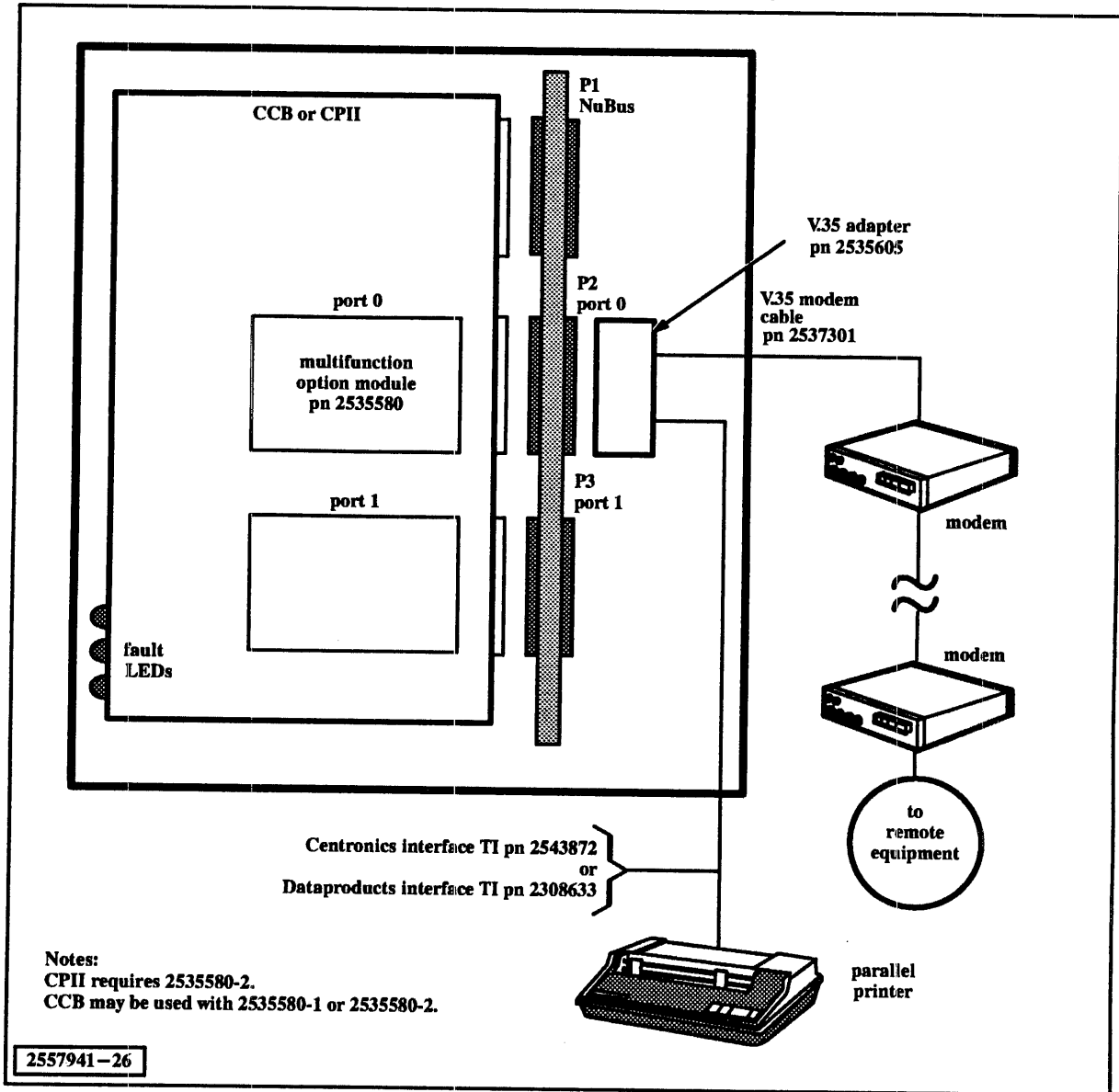

**Multidrop Option  
Module**

---

**3.2.5** The multidrop configuration shown in Figure 3-7 provides an interface to various terminals, printers, and modems via a multidrop terminal concentrator (MTC). It also provides an interface to a parallel printer which can be any of the printers listed in Table 3-7. The CK802 multidrop communication kit, TI part number 2554929-0001 (field-installable) or 2554929-0002 (factory-installed), contains the following components:

- Local MTC, TI part number 2554854-0001 — connects to the multidrop connector adapter via the MTC cable and provides connection to a maximum of eight terminals, printers, or modems.
- Multidrop connector adapter, TI part number 2554905-0001 — provides interfaces to the local MTC via a 4-pin modified jack (MJ) connector and to a parallel printer via a 40-pin MODU-type connector.
- MTC cable, TI part number 2554926-0001 — a twisted-pair cable that provides an MJ connector at one end for connection to the multidrop connector adapter and a terminal box at the other end that provides connection to a local MTC. The *Terminal Concentrator Installation and Operation* manual, TI part number 2557938-0001, provides detailed instructions for connecting the MTC and its supported devices.

The multidrop communication kit does not contain the parallel printer cable. However, the cables shown in Figure 3-7 (TI part numbers 2543872-0001 and 2308633-0001) are available from TI. Each of these cables contains a 40-pin MODU-type connector at one end for connection to the multidrop connector adapter.

The Centronics-type cable contains a 40-pin male Centronics-type connector at the peripheral end for connection to any of the parallel printers listed in Table 3-7. The Data Products type cable allows you to connect any parallel printer that provides a Data Products-type interface connector.

Figure 3-7 Multidrop Option Typical Configuration

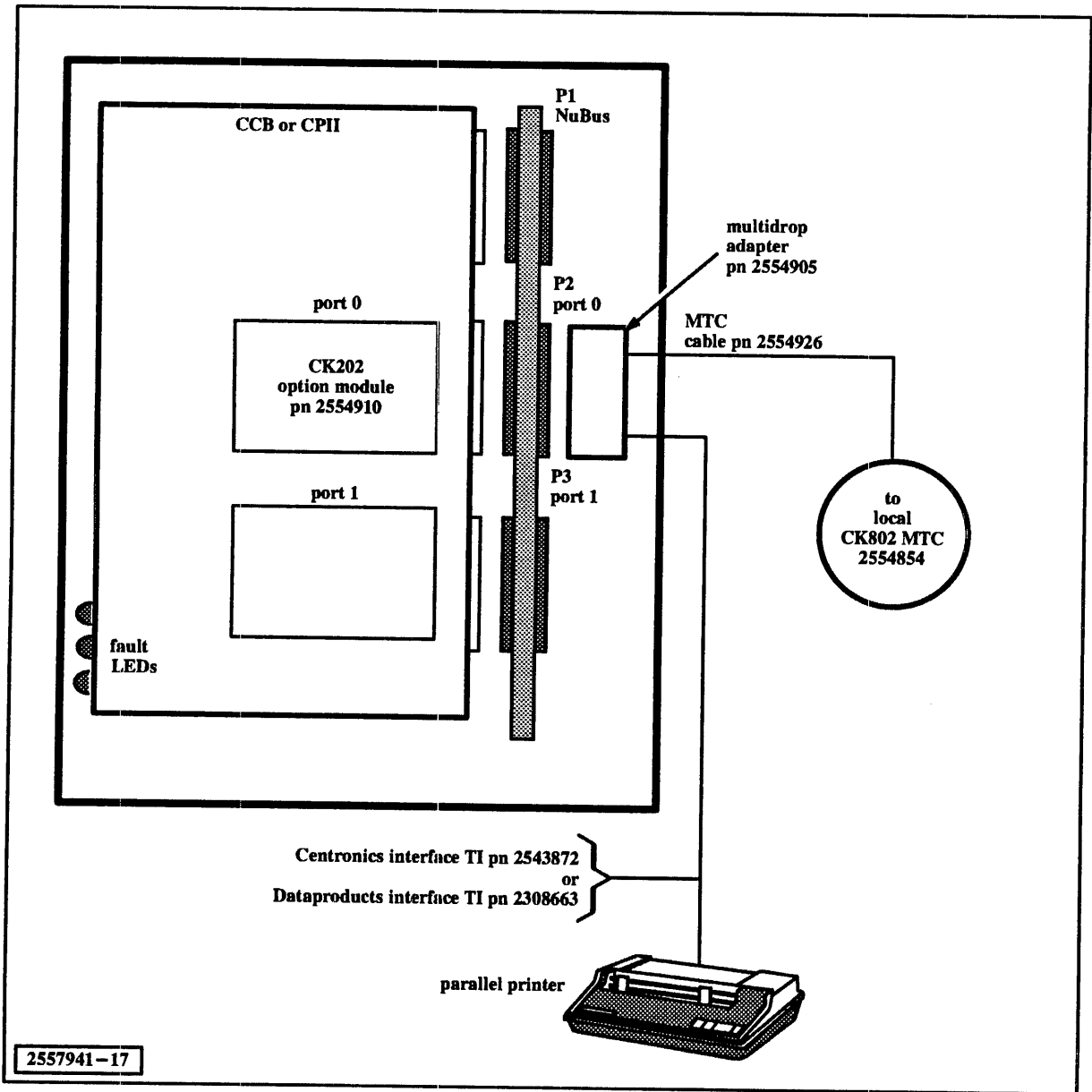

**Operation of the CCB LEDs**

3.3 The operation of the CCB LEDs is as follows:

- Top — Port 0 fault
- Center — Port 1 fault
- Bottom — Board fault

---

**Arranging for TI  
to Install Your  
Board**

**3.4** If you prefer to have TI install your board and its associated options rather than installing them yourself, contact the Field Service Communication Center (FSCC) at toll-free telephone number 1-800-572-3300 to schedule the installation. You will need to furnish the following information:

- The system serial number
- Your name and the name of your company
- Your company street address, city, state, and zip code and any special directions for finding the location
- The name and telephone number of the person to contact
- The purchase order number of the option to be installed



## Numbers

3-channel multifunction option board installation,  
3-13-3-18

4-channel asynchronous option board installation,  
3-3-3-5, 3-6-3-8, 3-9-3-12

## A

adapter board caution, 3-2

## B

boards

  general description, 1-5-1-6

  installation, 3-1-3-19

  shipping container, 2-2

  TI installation, 3-1-3-18, 3-19

  unpacking, 2-1-2-3

## C

cable adapters

  shipping container, 2-3

  TI installation, 3-1-3-18, 3-19

  unpacking, 2-1-2-3

cautions

  adapter board, 3-2

  static electricity, 2-1, 3-1

CK202 option board installation, 3-17-3-18

communications carrier board (CCB)

  general description, 1-5-1-6

  LED indicators, 3-18

  shipping container, 2-2

  unpacking, 2-1-2-3

## E

electrical shock warning, 3-1

## I

indicators, LED, 3-18

installation

  3-channel multifunction option board,  
  3-13-3-18

  4-channel asynchronous option board, 3-3-3-5,  
  3-6-3-8, 3-9-3-12

  cautions, 3-1, 3-2

  CK202 option board, 3-17-3-18

  warnings, 3-1

## L

LED indicators, 3-18

lithium battery warning, 2-1

## S

shipping container

  cable adapter, 2-3

  system board, 2-2

static electricity caution, 2-1, 3-1

system boards. *See* boards

## T

TI-installation

  cable adapters, 3-1-3-18, 3-19

  system boards, 3-1-3-18, 3-19

## U

unpacking

  cable adapters, 2-1-2-3

  cautions, 2-1

  system boards, 2-1-2-3

  warnings, 2-1

## W

warnings

  electrical shock, 3-1

  lithium battery, 2-1

# Information Technology Group – Austin Documentation Questionnaire

## System Board Installation and Operation

Do you use other TI manuals? If so, which one(s)?

How would you rate the quality of our manuals?

	Excellent	Good	Fair	Poor
Accuracy	_____	_____	_____	_____
Organization	_____	_____	_____	_____
Clarity	_____	_____	_____	_____
Completeness	_____	_____	_____	_____
Overall design	_____	_____	_____	_____
Size	_____	_____	_____	_____
Illustrations	_____	_____	_____	_____
Examples	_____	_____	_____	_____
Index	_____	_____	_____	_____
Binding method	_____	_____	_____	_____

Was the quality of documentation a criterion in your selection of hardware or software?

- Yes
  No

How do you find the technical level of our manuals?

- Written for a more experienced user than yourself  
 Written for a user with the same experience  
 Written for a less experienced user than yourself

What is your experience using computers?

- Less than 1 year
  1-5 years
  6-10 years
  Over 10 years

We appreciate your taking the time to complete this questionnaire. If you have additional comments about the quality of our manuals, please write them in the space below. Please be specific.

---



---



---



---



---

Name \_\_\_\_\_ Title/Occupation \_\_\_\_\_  
 Company Name \_\_\_\_\_  
 Address \_\_\_\_\_ City/State/Zip \_\_\_\_\_  
 Telephone \_\_\_\_\_ Date \_\_\_\_\_

TAPE EDGE TO SEAL

FOLD



NO POSTAGE  
NECESSARY  
IF MAILED  
IN THE  
UNITED STATES

**BUSINESS REPLY MAIL**

FIRST-CLASS PERMIT NO. 7284 DALLAS, TX

POSTAGE WILL BE PAID BY ADDRESSEE

TEXAS INSTRUMENTS INCORPORATED  
INFORMATION TECHNOLOGY GROUP  
ATTN: PUBLISHING CENTER  
P.O. BOX 149149 M/S 2220  
AUSTIN TEXAS 78714-9149

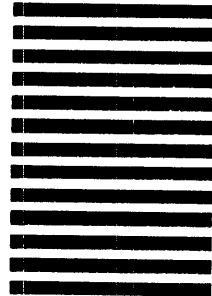

FOLD

---

---

---

---

---

---

---

---

2557941-0001\*F

---

